













# PAT100 Series Portable Appliance Tester

## User Guide

**Megger**

[WWW.MEGGER.COM](http://WWW.MEGGER.COM)

Unpacking the carton	3
Safety warnings	4
Symbols used on the instrument	5
Symbols used on the connection panel	6
Instrument layout	7
PAT120 and display information	7
PAT150 and display information	7
Measurement symbols	8
Instrument buttons	9
User guide INSTRUCTION symbols	9
Carry strap fitting and removal	10
Switching ON / OFF	11
Class I test  (PAT120, 150) using substitute leakage @ 40 V ac	12
Class I test  (PAT120, 150) using mains leakage @ 230 V ac	14
Class II test  (PAT120, 150) Using Substitute Leakage @ 40 V ac	15
Class II test  (PAT120, 150) Using Mains Voltage Leakage @ 230 V ac	16
Power cord test  (PAT120, 150)	17
Extension lead test  (PAT120, 150)	18
Portable RCD test  (PAT150)	19
Fixed equipment testing	20
Fail handling	21
Quick test  (PAT150 only)	22
Quick test examples	23
SELV measurement within quick test (QT)	25
To exit quick test (QT) mode	25

SETUP  (PAT120, PAT150)	26
Changing PASS limits and test times	26
Continuity lead null	27
RCD configuration	28
Factory reset to default settings	29
Region selection  (only available on first power-on from new or after factory reset)	30
International model variations	31
Battery and fuse replacement (PAT120, 150)	32
Battery replacement	32
Fuse replacement	33
Preventive maintenance	33
Specification	34

Thank you for purchasing the Megger portable appliance tester.

For your own safety and to get the maximum benefit from your instrument, please ensure that you read and understand the safety warnings and instructions before attempting to use the instrument.

These instruments are designed and manufactured by:

**Megger Instruments Limited**  
Archcliffe Road  
Dover Kent  
CT17 9EN  
England

Megger Instruments Limited reserves the right to change the specification of these instruments at any time without prior notice.

## Unpacking the carton

Unpack the carton contents carefully. There are important documents that you should read and keep for future reference.

Please complete the pre-paid warranty card and return it to Megger Limited as soon as possible to help us reduce any delays in supporting you should you need assistance.



## Safety Warnings

The following Safety Warnings and Precautions **must** be read and understood before the instrument is used. They **must** be observed during use.

- Only use test leads and accessories supplied or approved by Megger Instruments Limited
- At any time the ⚠ symbol or ⚡ symbol is displayed, the user guide and warnings documentation must be consulted to identify the nature of the hazard and any actions necessary to avoid the hazard
- Do not use the instrument if there are any signs of damage
- This instrument meets the EMC requirements of Class A applications. Not for use in domestic installations
- All test leads, probes and clips **must** be in good order, clean and with no broken or cracked insulation
- Probes and clips should be held behind the finger guard
- Test leads not used during a measurement should be disconnected from the Appliance tester
- During testing, ensure no hazard will exist as a result of normal running or under fault conditions
- During testing the unit under test (appliance) should not be touched, other than using the appropriate accessories, as faulty appliances can present a shock hazard
- Do not touch the exposed parts of test leads during tests as hazardous voltages may be present
- Do not intentionally connect test leads to live systems or hazardous voltages
- Do not touch the IEC extension lead socket pins especially during a test, as hazardous voltages may be present due to a potentially faulty appliance
- Do not touch the exposed earth pins of the 230 V test socket during a test, as voltages may be present due to a potentially faulty appliance
- Serviceable fuses should only be replaced with those that are suitably rated
- Replacement fuses **must** be of the correct rating and type. **Refer to page 33**
- If this instrument is used in a manner not specified in the supplied documentation, the protection provided by the instrument may be compromised

### PAT150

- For safety, only connect the PAT to a supply that is properly earthed. If in doubt, the supply should be checked by a qualified electrician
- Only perform a mains powered leakage test after the Earth bond and insulation tests have been completed, as this test operates at mains voltage
- During mains powered leakage tests the appliance under test will operate. Make sure the appliance is safely secured to ensure no damage or danger is possible
- A yearly calibration is recommended with interim checks on measurement accuracy to ensure no equipment can be left in a hazardous live condition through incorrect readings
- Only use a Megger approved PAT100 charger. Other chargers may present a fire risk
- Do not connect the battery charger to the PAT150R whilst running a test
- During testing make sure that the shutter covers the battery charger port. There is a risk of electrocution from exposed terminals. Do not touch any exposed terminals or probe tips during test
- Always remove the mains plug test lead  from the mains supply AND the instrument when not in use

## Product Safety Category

CATII 300 V - MEASUREMENT CATEGORY II Equipment connected between the electrical outlets and the user's equipment.

 **230 V ac powered Leakage testing:** Connecting the PAT150 to a 230 V ac supply will automatically switch the leakage tests from a 40 V ac test to a mains powered 230 V ac test. Any leakage testing performed with 230 V ac connected will operate the equipment under test. Ensure the equipment under test is properly secured and in a safe condition prior to running a 230 V ac leakage test

### WEEE DIRECTIVE

The crossed out wheeled bin symbol placed on Megger products is a reminder not to dispose of the product at the end of its life with general waste. Megger is registered in the UK as a Producer of Electrical and Electronic Equipment. The Registration No is WEE/HE0146QT. For further information about disposal of the product consult your local Megger company or distributor or visit your local Megger website.

## Symbols used on the instrument



Caution: refer to accompanying notes.



Danger: Mains voltage present during testing



Equipment complies with relevant EU Directives



Equipment complies with 'C tick' requirements

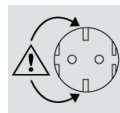

Caution: Earth pins of the 230 V test socket will become hazardous if test lead P1 is in contact with hazardous voltages during continuity test.



Fuse failure



This equipment should be disposed of as electronic waste



Battery type fitted



Do not connect to 230 V supply



Caution: Earth pin of the 230 V test socket will become hazardous if test lead P1 is in contact with hazardous voltages during continuity test

## Symbols used on the connection panel

PAT120 connector panel

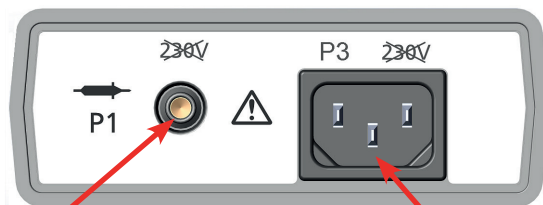

**P1**   
Continuity (Bond),  
Insulation and Touch  
leakage probe  
connection

**P3**   
IEC power cord  
and extension lead  
adaptor socket.

 Do NOT connect P1 and P3 sockets to hazardous live voltages

PAT150 connector panel

**Mains I/P**   
Used for testing  
that require  
mains power to  
be applied to the  
equipment under  
test, such as:  
- PRCD testing  
- Mains powered  
earth leakage  
tests

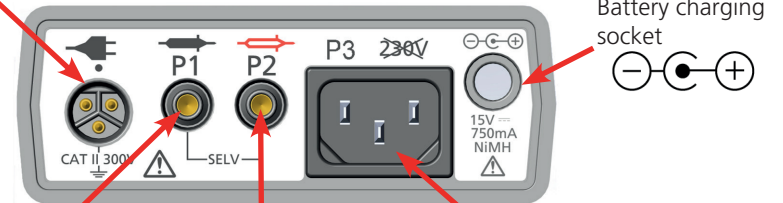

**P1**   
Continuity (Bond),  
Insulation and Touch  
leakage probe connection

**P2**   
Used with P1 for testing  
Separated Extra Low  
Voltages and Mains  
voltages

**P3**   
IEC power cord  
and extension lead  
adaptor socket.  
Do NOT connect to  
230 Vac

 Do NOT connect P1, P2 and P3 sockets to hazardous live voltages



## Instrument Layout PAT120

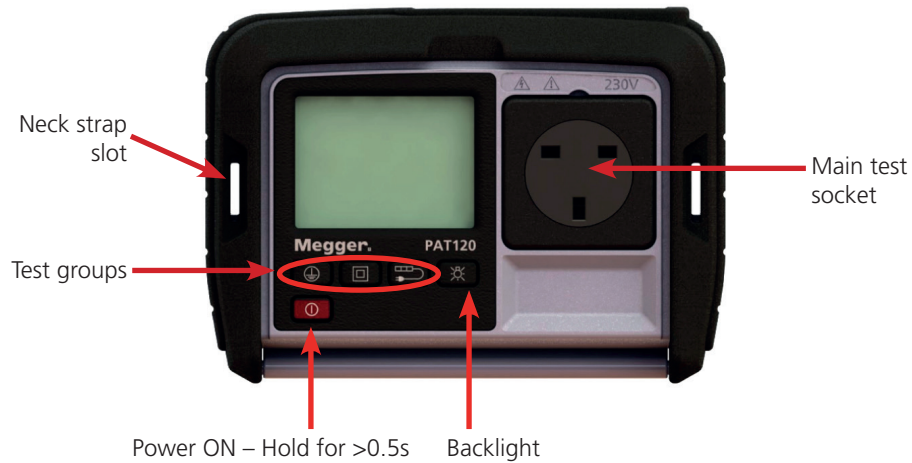

## Instrument Layout PAT150

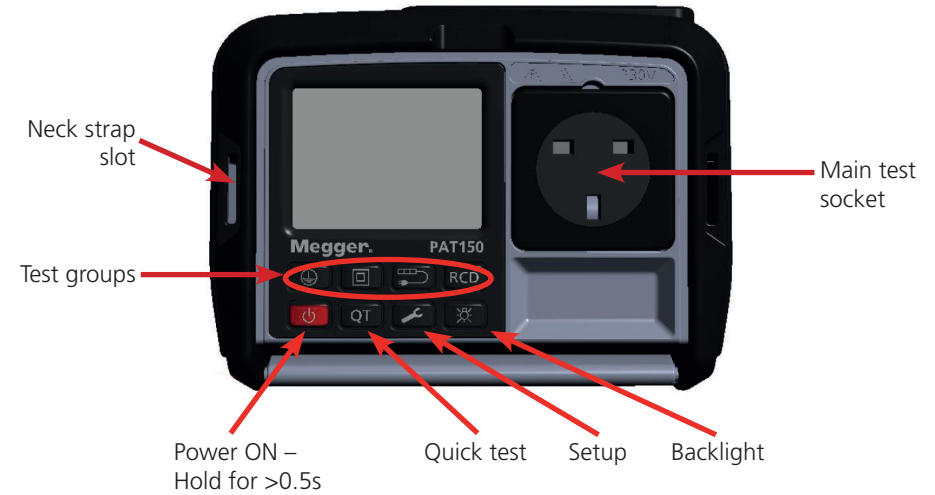

## Display information PAT120

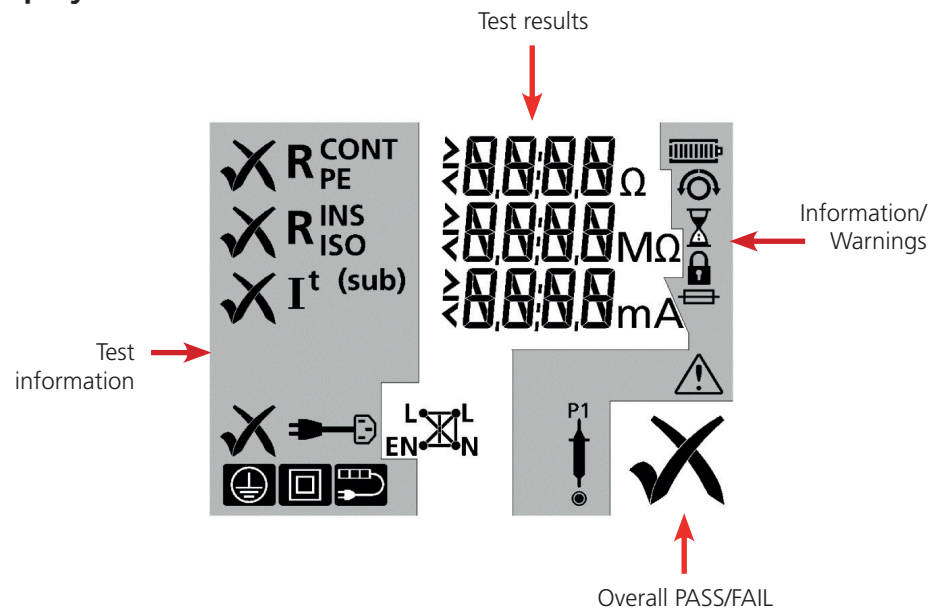



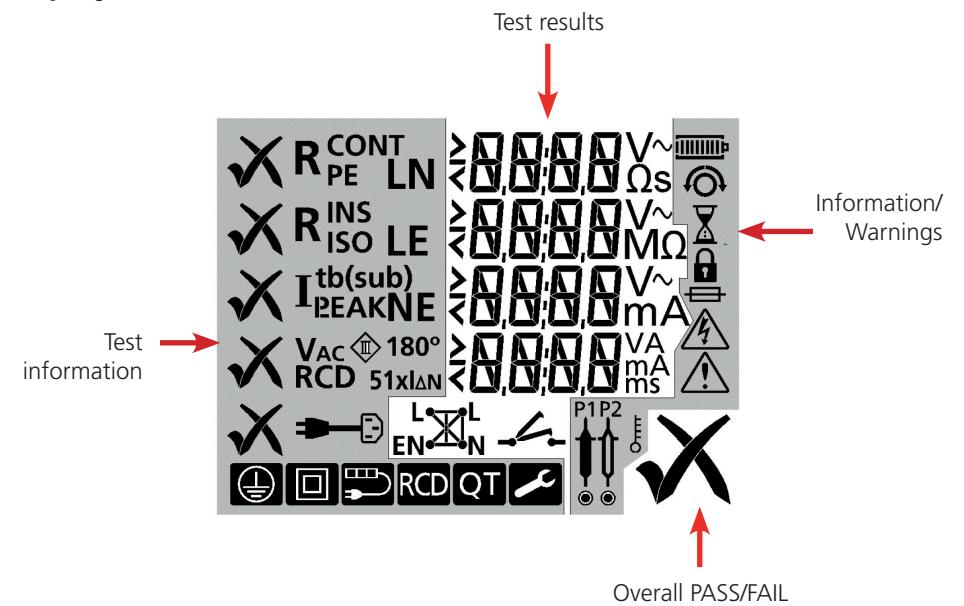











## Display information PAT150













## Measurement (display) symbols

PAT120 & PAT150

<b>R<sub>CONT PE</sub></b>	Continuity of the protective earth conductor		Test in progress
<b>R<sub>INS ISO</sub></b>	Insulation resistance between the Live/Neutral conductors and earth		Measurement locked ON
<b>I<sub>EA</sub></b>	Alternative method:- 40 V ac leakage test for protective conductor current and touch current. Battery powered test		Notice: Refer to user guide
			Resistance in ohms
<b>I<sub>LEAK (sub)</sub></b>	(English language models) Alternative method:- 40 V ac leakage test for for protective conductor current. Battery powered test	<b>MΩ</b>	Insulation resistance in Meg Ohms (ohms x 1x10 <sup>6</sup> )
		<b>mA</b>	Leakage current in milliamps
<b>I<sup>t</sup> (sub)</b>	(English language models) Alternative method:- 40 V ac leakage test for for touch current. Battery powered test		Cable polarity correct
	Power lead or Extension lead polarity test		Live to Neutral cross polarity
	Test probe P1 to be connected		Live to Neutral short circuit detected
	Test or overall test group passed		Live to Earth short circuit detected
	Test or overall test group failed		Open circuit detected
	Fuse failed		General warning - Appliance open circuit or not switched on

PAT150 only

<b>RCD</b>	Residual current device test mode		Test Probe P2 to be connected
<b>0°</b>	0° - Positive edge test current		Instrument hot, allow to cool
<b>180°</b>	180° - Negative edge test current		
<b>1xIΔN</b>	1 x IΔn = the rated operating current of the RCD		Lead null active
<b>5xIΔN</b>	5 x IΔn = 5 time the rated operating current of the RCD		Warning: Hazardous voltages present
<b>V~</b>	Volts AC		P1 test lead null set
<b>s</b>	Seconds		Extension lead adaptor lead null set
<b>ms</b>	Thousandths of a second	<b>I<sub>PE</sub></b> <b>I<sub>LEAK</sub></b>	Earth leakage current measured using the differential/residual method
	RCD – Press TEST or RESET	<b>LN</b>	Phase to Neutral voltage
<b>I<sup>t</sup><sub>B</sub></b>	Touch current measured with P1 test probe using the direct method	<b>NE</b>	Neutral to Earth Voltage
<b>LE</b>	Phase to Earth voltage	<b>VAC</b> 	Separated Extra-Low Voltage measurement
<b>VAC</b>	Volts AC (measurement function)	<b>R<sub>CONT</sub></b> 	(English language models) Fixed installation equipment continuity test
	Repeat continuity test	<b>R<sub>PE</sub></b> 	Fixed installation equipment continuity test

NOTE: The PAT100 instruments perform various pre-checks prior to testing to ensure the asset is not short-circuit and is switched on





## Instrument Buttons



Power button - Hold down for 0.5 second to switch on,  
Hold down for 2 seconds to switch off  
Abort button - press to stop test or exit a setup mode



Class I button



Class II button



Extension lead button



Quick test button



RCD test button



Setup button – allows access to PASS limits, test times and lead null option



Backlight button

## User guide INSTRUCTION symbols

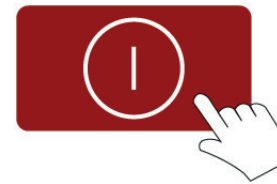

Press the button

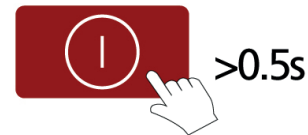

Press and hold for greater than 0.5 seconds

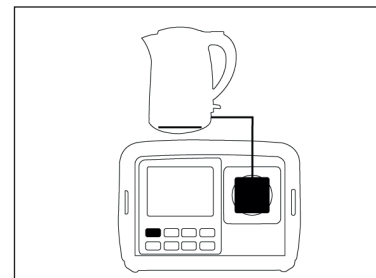

Connect the equipment to be tested to the instrument

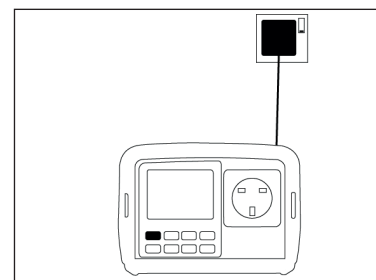

Connect the Instrument to the mains supply using the mains plug test lead (for mains powered leakage and RCD testing)

## Carry strap fitting and removal

Fitting the carry strap:



Removing carry strap:

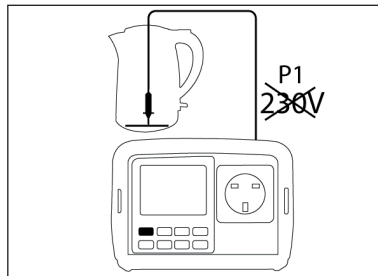

Connect the P1 test lead to socket P1 on the Pat100 and the probe to exposed metalwork. Ensure the probe is NOT connected to a 230V source.

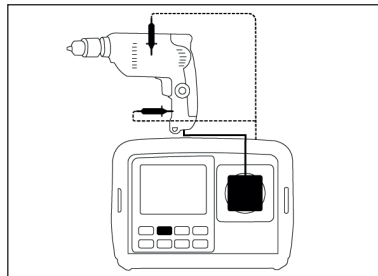

Connect the P1 test lead to different conductive points on the equipment under test during the measurement.

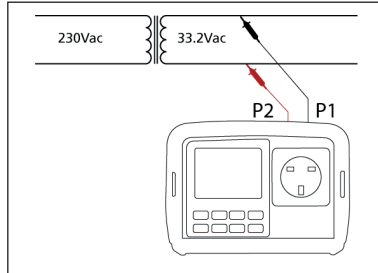

Connect both the P1 and P2 test leads to the circuit to be measured.

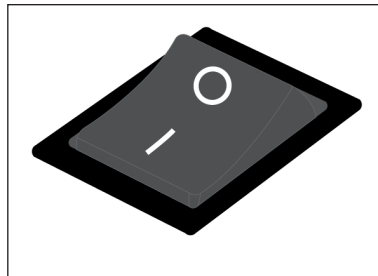

Ensure equipment under test is switched ON.

## Switching ON / OFF

### Switching ON

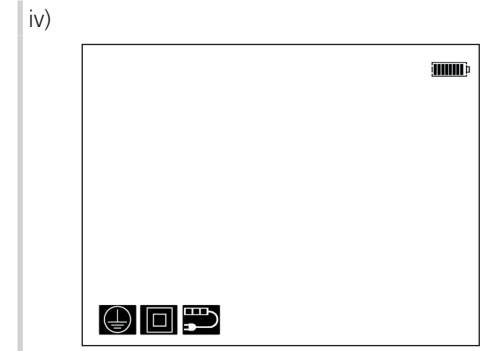
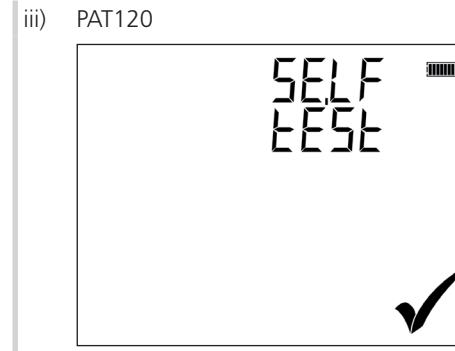
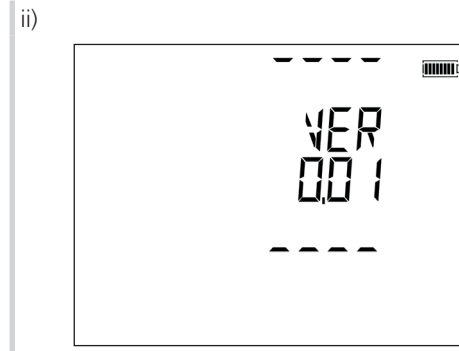

### Switching OFF

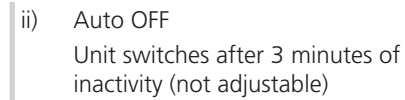

### Backlight



### Aborting a test

A test can be aborted at any time by pressing the Power (ESC) button



## Class I test (PAT120, 150) using substitute leakage @ 40 V ac

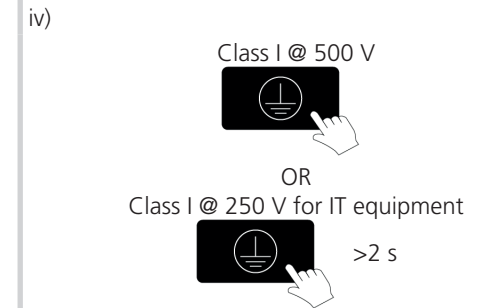
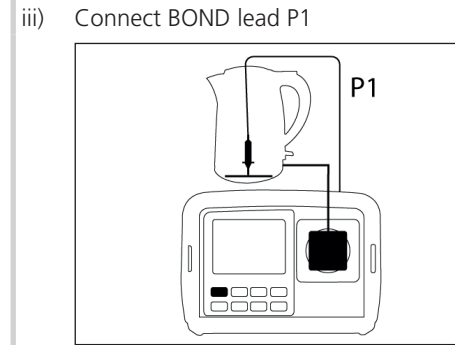
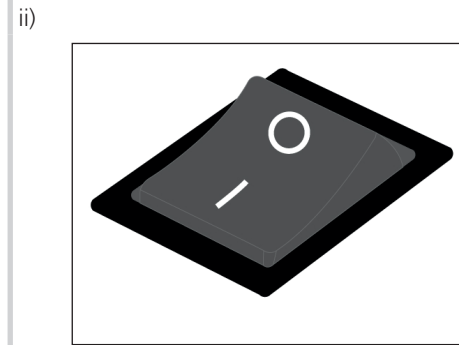
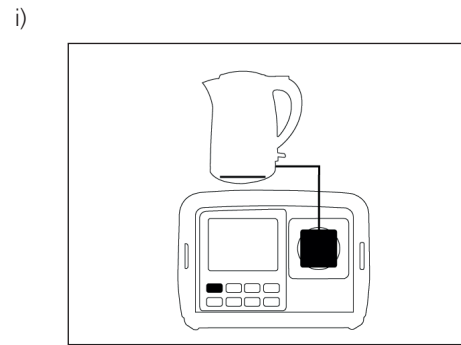

v) Ensure probe (P1) is connected

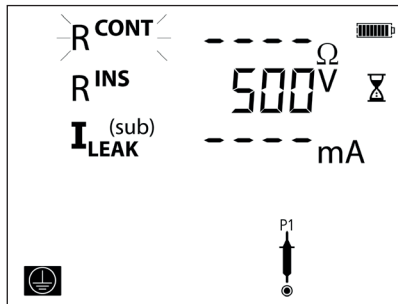

vi) Remove probe (P1)  
See note below

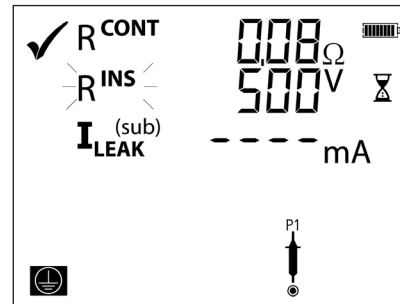

vii)

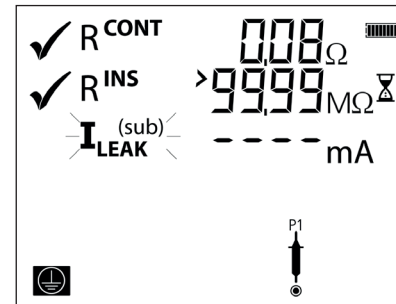

viii) Class I Pass

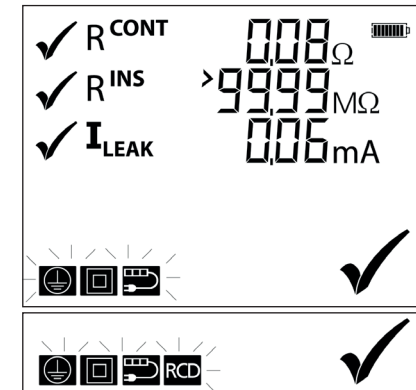

NOTE: If the contact symbol  is displayed during the test, the PAT has detected an open circuit load. Ensure the appliance is switched on then press the Class I icon

NOTE: The PAT100 instruments perform various pre-checks prior to testing to ensure the asset is not short-circuit and is switched on

To repeat a continuity test (PAT150 Class I and Extension lead tests only  $R^{CONT}$  or  $R_{PE}$ ):

Press **QT** key during  $R^{CONT}$  (or  $R_{PE}$ ) test to enable repeat test. The  symbol will be displayed.

When the timer symbol has disappeared and the repeat symbol is flashing, press **QT** to run repeat test

Press  or  to exit repeat test

To repeat continuity test with 1.0  $\Omega$  limit (NOT available on UK models)

At the end of a FAILED continuity test the  symbol will flash for up to 5 seconds.

Press the  or  button to repeat the test within the 5 seconds.

The test will be repeated with a 1.0  $\Omega$  pass limit.

Lock a test in the ON state:

$R^{CONT}$  ( $R_{PE}$ ) or  $R^{INS}$  ( $R_{ISO}$ ) can be locked ON () during a test for up to 3 minutes. To Lock  $R^{CONT}$  ( $R_{PE}$ ) or  $R^{INS}$  ( $R_{ISO}$ ) on:

Press ,  or  during the  $R^{CONT}$  ( $R_{PE}$ ) or  $R^{INS}$  ( $R_{ISO}$ ) test

Press key again to unlock test and proceed to next test

**NOTE** : This feature is available in group test and QT mode.

## Class I test (PAT150) using mains voltage leakage @ 230 V ac Mains powered testing of equipment with an Earth return conductor

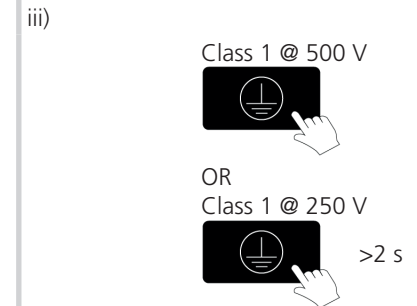
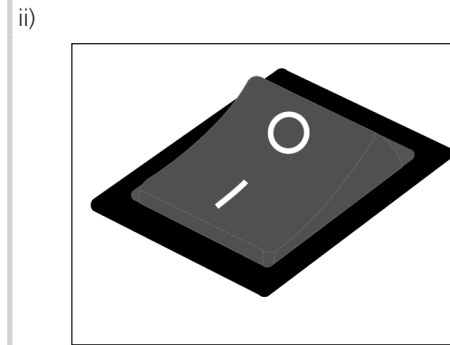
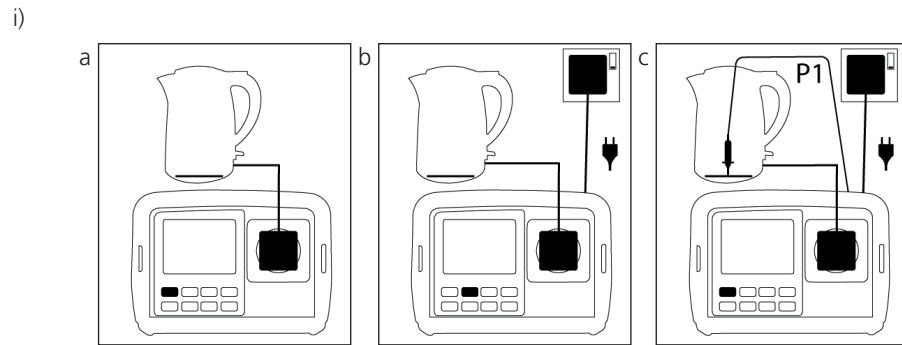

iv) Ensure probe P1 connected

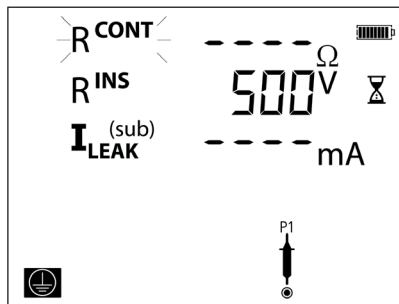

v) See note 1

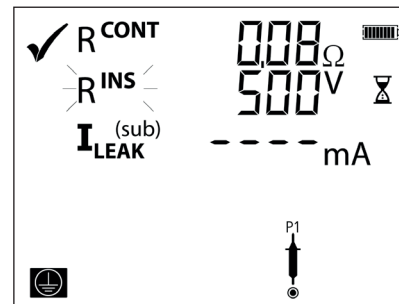

vi) See notes 1, 2 & 3 below

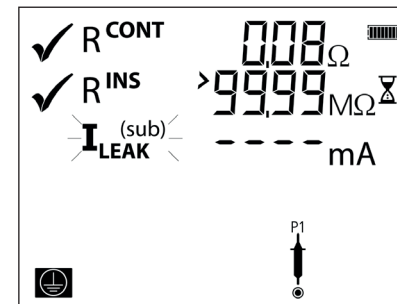

vii) **Warning: Appliance will operate**



viii) Class 1 Pass

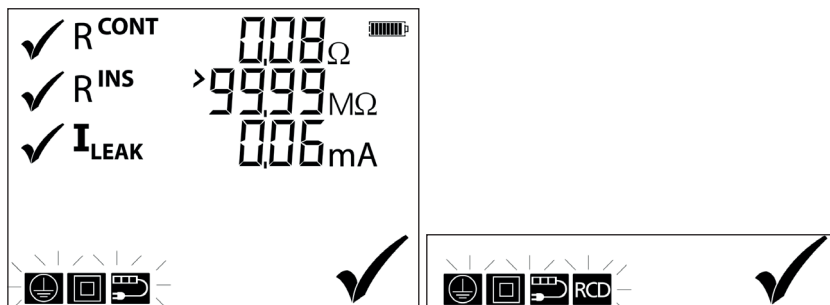



**NOTE 1** : If the contact symbol  appears, the appliance needs to be switched ON.  
**NOTE**: The PAT100 instruments perform various pre-checks prior to testing to ensure the asset is not short-circuit and is switched on

**NOTE 2**: If the L-N or L-E symbol is flashing a low resistance has been detected. An L-E fault will stop the test. See Measurement symbols table.  
An L-N fault could damage the PAT tester and should be investigated.  
To override an L-N warning, press the Class I button.

**NOTE 3** : Faulty equipment may cause an RCD to trip during a Touch leakage test

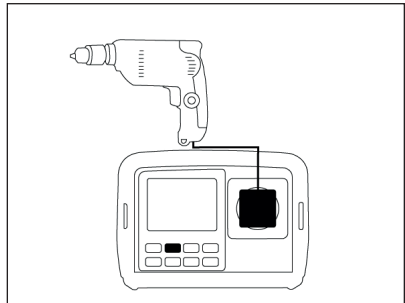
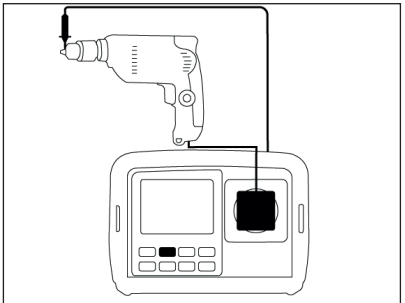
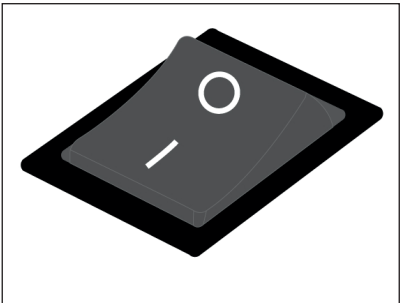
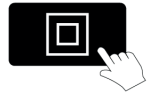

## Class II test (PAT120, 150) using substitute leakage @ 40 V ac Battery powered testing of equipment without an Earth return conductor

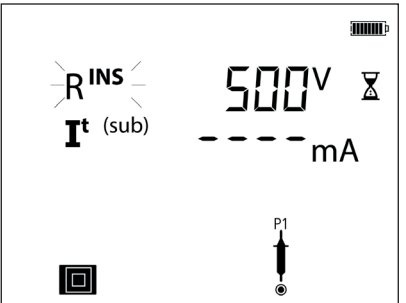
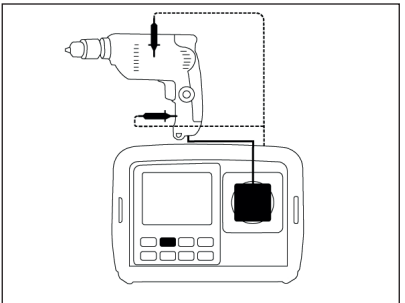
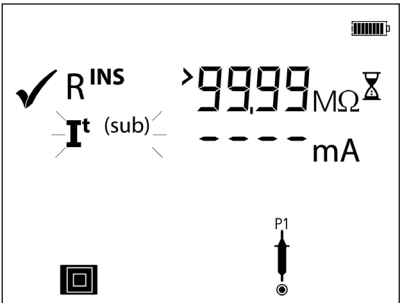
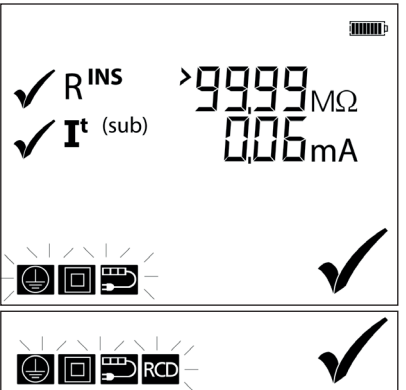
<p>i) a</p> 	<p>b</p> 	<p>ii)</p> 	<p>iii)</p> <p>Insulation test @ 500 V</p>  <p>OR</p> <p>Insulation test @ 250 V</p>  <p>&gt;2 s</p>
<p>iv) Ensure probe (P1) is connected</p> 	<p>v) Repeat contact on all exposed conductive parts</p> 	<p>vi) See note below</p> 	<p>vii) Class II Pass</p> 

NOTE: If the contact symbol  appears, the appliance needs to be switched ON  
 NOTE: The PAT100 instruments perform various pre-checks prior to testing to ensure the asset is not short-circuit and is switched on

## Class II test (PAT150) using mains voltage leakage @ 230 V ac Mains powered testing of equipment without an Earth return conductor

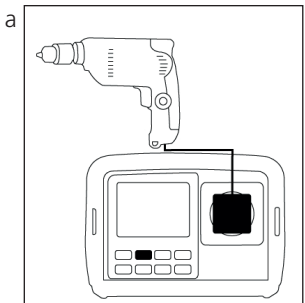
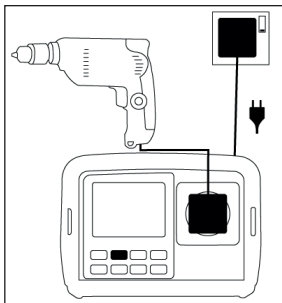
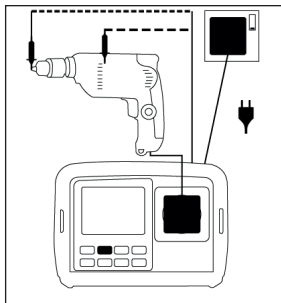
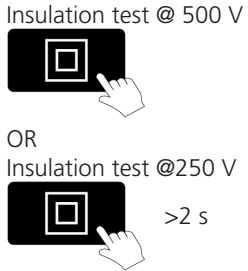
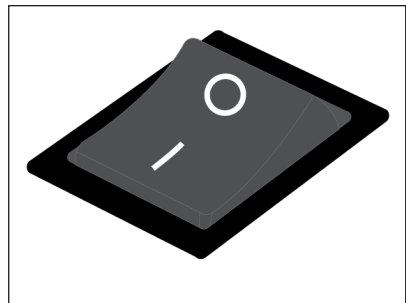
i)    ii)  iii) 

---

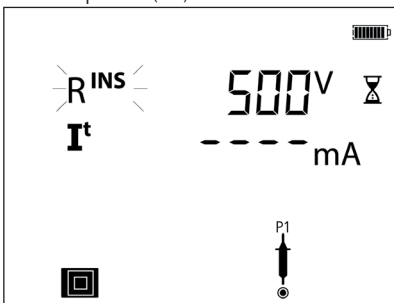
iv) Ensure probe (P1) is connected 

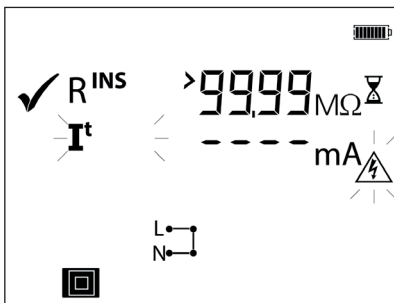
v) See note 1 below 

vi) **Warning: Appliance will operate!** 

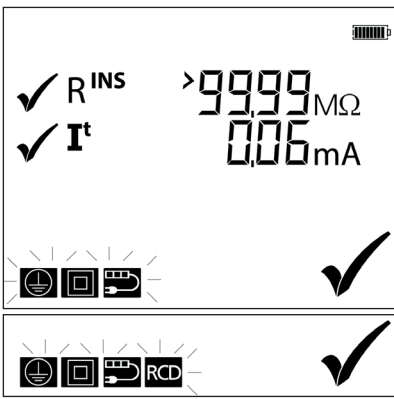
vii) Class II Passed 

If the L to N short circuit symbol shows, user must check whether there is a true short circuit. Press Class II button to proceed but there is a risk of damage or tripping of protective devices.

**NOTE :** High touch leakage measurement on faulty equipment can trip the supply RCD

**Warning:** High inertia appliances (eg angle grinders) may present a hazard whilst running. It is recommended that where a hazard is likely, the battery powered "Substitute leakage" test is used, which will not operate the appliance.



## Power cord test (PAT120, 150)

Testing a standard power cord

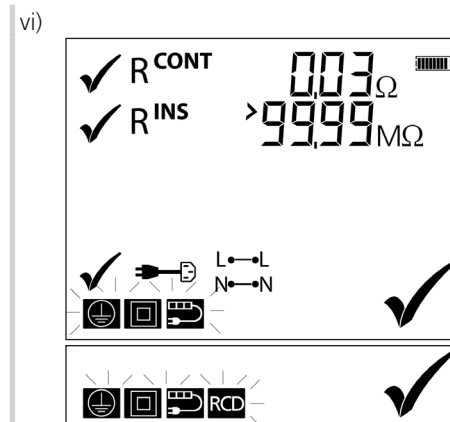
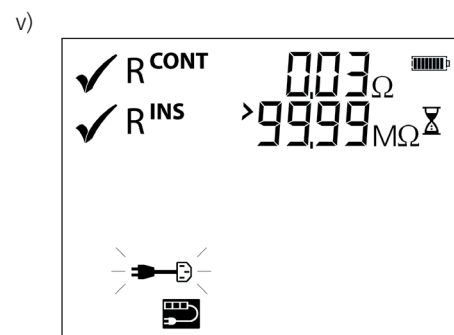
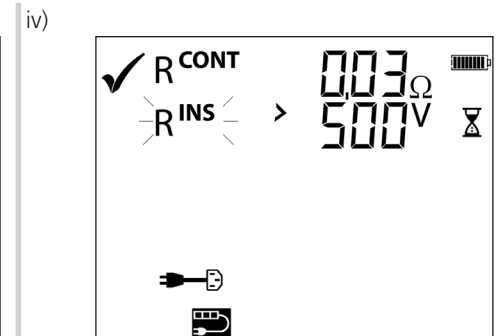
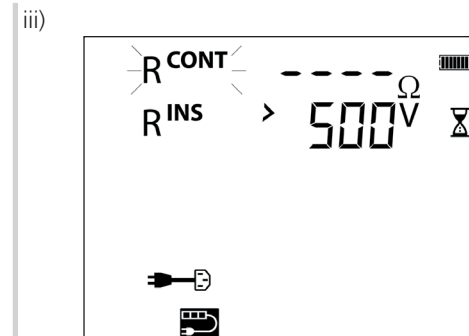
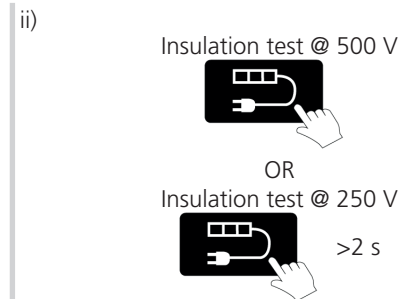
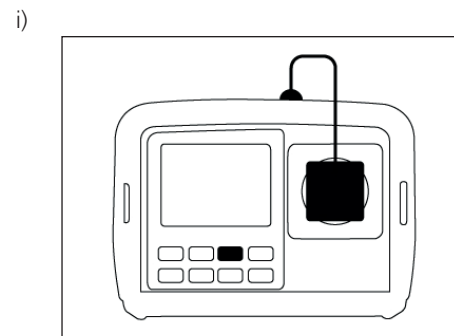

NOTE : For power cords longer than 5m the test can be re-run with a 1.0Ω pass limit by pressing the  test button with 5 seconds of the continuity test failing – refer to page 13

## Extension lead test (PAT120, 150)

Testing an extension lead or multi-way extension lead

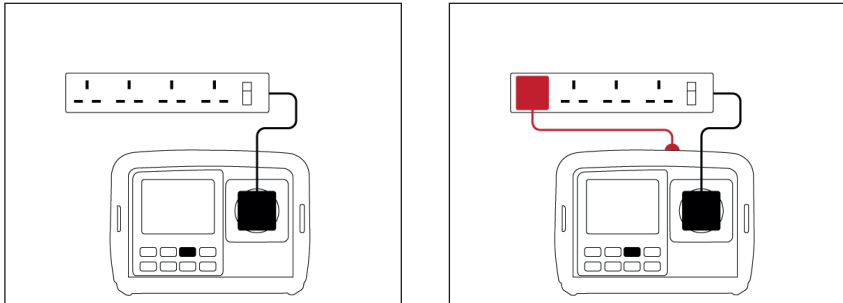
i) 

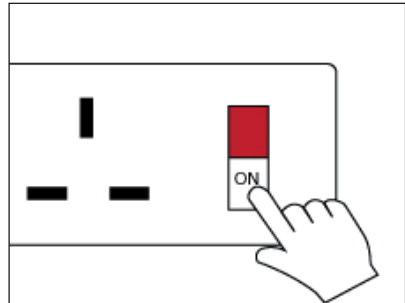
ii) 

Insulation test @ 500 V  
OR  
Insulation test @ 250 V  
>2 s

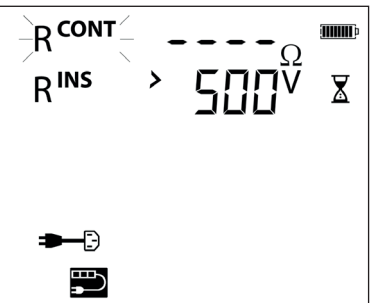
iii) 

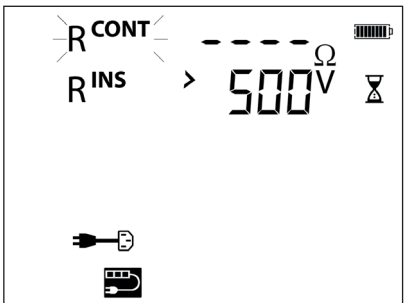
iv) 

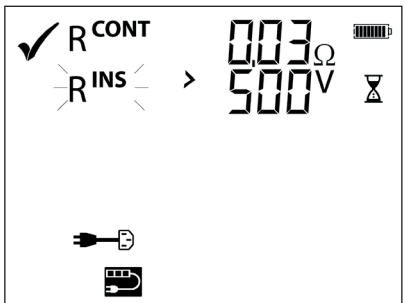
v) 

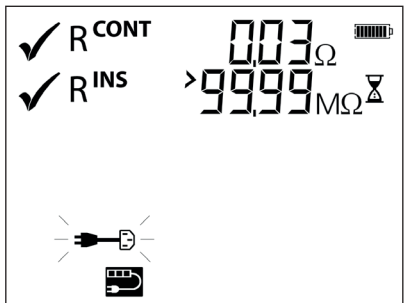
vi) 

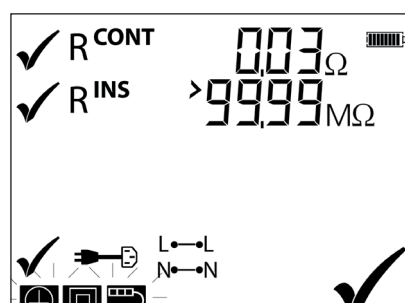
vii) 

**NOTE:** Multiple earth continuity tests can be carried out by pressing the QT button during the continuity test, and pressing it again for each new continuity test. See Page 13

## Portable RCD test **RCD** (PAT150)

Testing a portable RCD or extension lead with built-in RCD

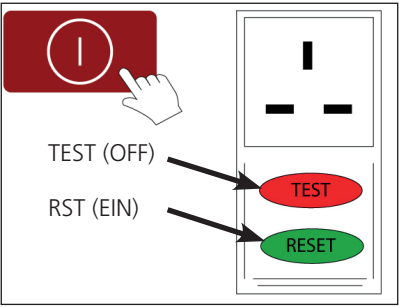
i) 

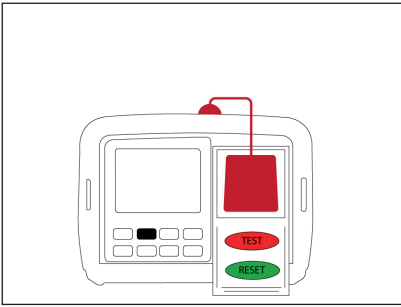
ii) Connect RCD 

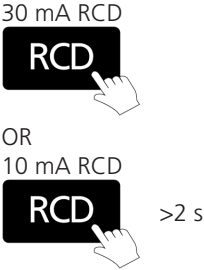
iii) See note below 

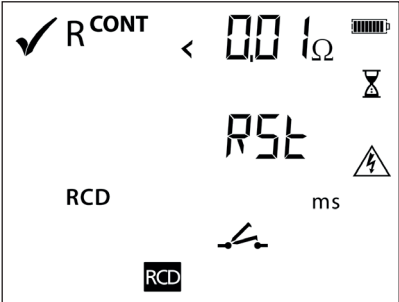
iv) Press RESET on RCD 

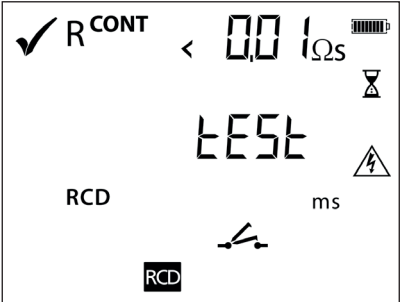
v) Press TEST button on RCD 

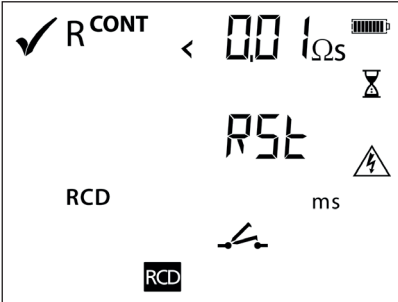
vi) Press RESET on RCD 

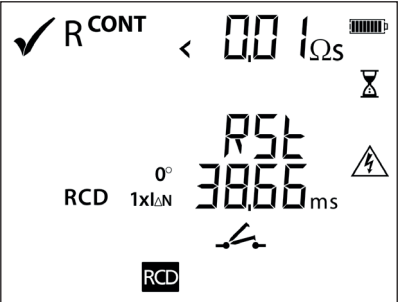
vii) Press RESET on RCD 

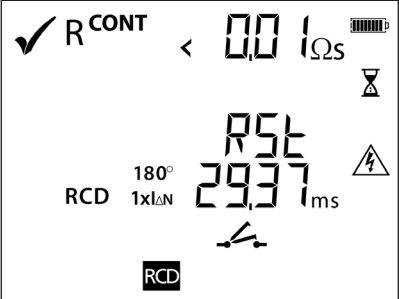
viii) Press RESET on RCD 

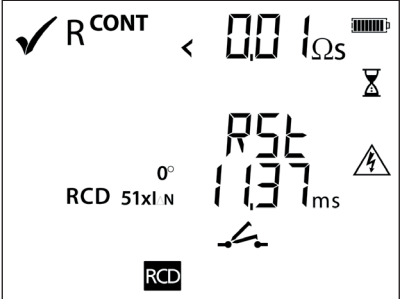

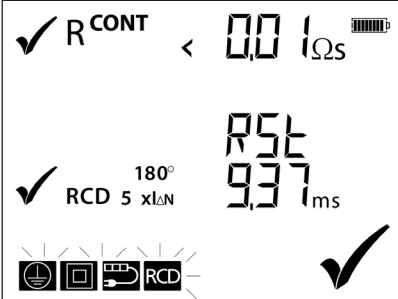

ix) Press RESET on RCD 

x) Test complete 

**Note :** The PAT150 defaults to 30 mA RCD. To change to 10 mA, hold the RCD button down for more than 2 seconds then release.

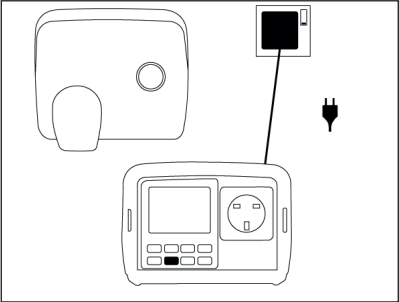
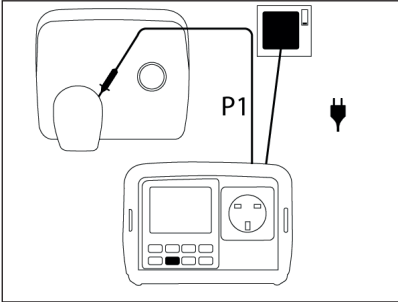
## Fixed equipment testing (PAT150, 150R)

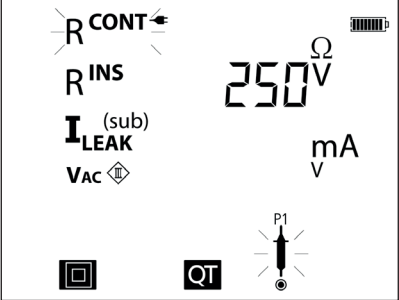
Only a continuity test is possible when testing fixed equipment without disconnecting the incoming supply. Use the Quick Test (QT) button to access the continuity test mode:

- i) 
- ii) Ensure probe (P1) is connected 
- iii) 
- iv) Press 5 times to display **R<sup>CONT</sup>**  x 5
- v) Continuity test 
- vi) 
- vii) Test complete 



## Fail Handling

i) Individual test fail indicated by a small cross:

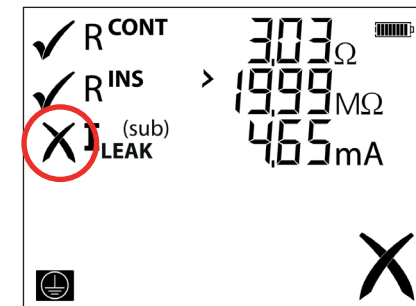
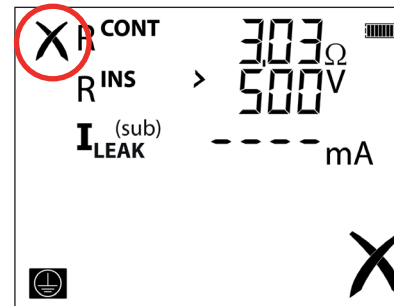

ii) Overall FAIL indicated by a large cross:

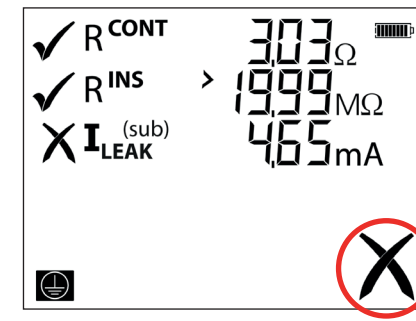
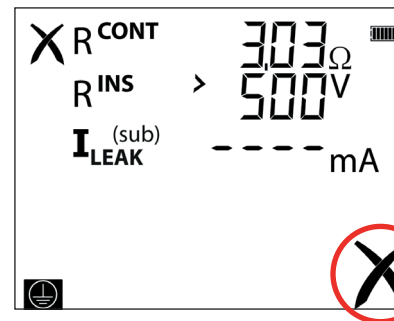

NOTE : Once an appliance has failed a test, further testing of the test group sequence is prevented for safety reasons, except for the extension lead testing

## Quick test **QT** (PAT15, 150R)

QT = Quick test - Access to individual tests within a test group.

To access Quick Test mode:

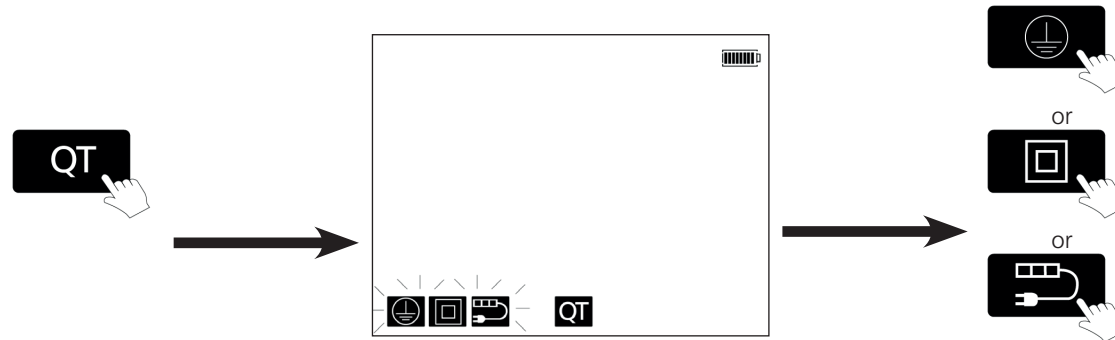

Connection for individual tests differs depending on the test group selected.

### Options:

#### Class I

- Continuity (Uses P1 probe)
- Insulation 500 V
- Insulation 250 V
- Substitute Leakage
- Mains Leakage (needs mains connection)

#### Class II

- Insulation 500 V (uses P1 probe)
- Insulation 250 V (uses P1 probe)
- Substitute leakage (uses P1 probe)
- Mains leakage (uses mains connection and P1 probe)
- SELV measurement (uses P1 and P2 probes)

#### Extension lead

- Continuity (uses extension lead adaptor)
- Extension Lead, Insulation 500 V
- Extension Lead, Insulation 250 V
- Polarity (uses extension lead adaptor)

## Quick Test (QT) options

### Example 1- Class I continuity

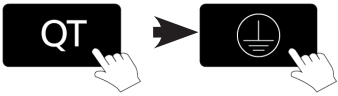
i) 

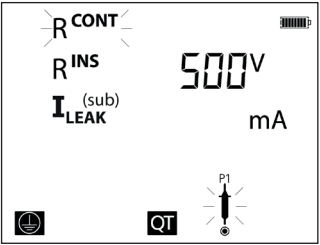
ii) 

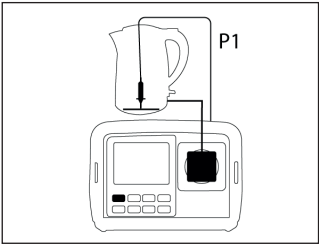
iii) 

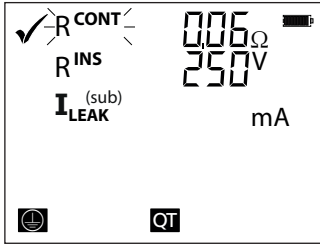

iv) 

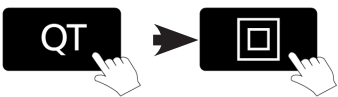
### Example 2 – Class II 250 V Insulation test

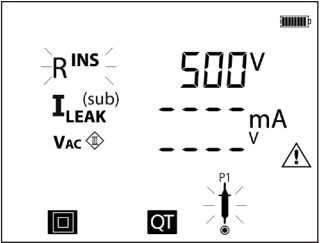
i) 

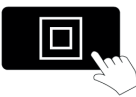
ii) 

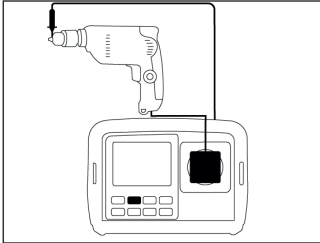
iii) 

iv)  

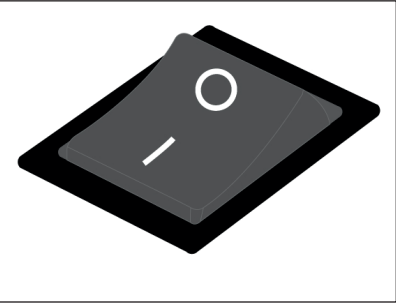
v) 

vi) 

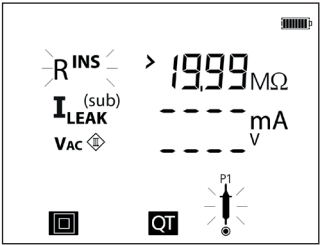

**Example 3 – Class II touch leakage test using the Substitute (or alternative) method.**

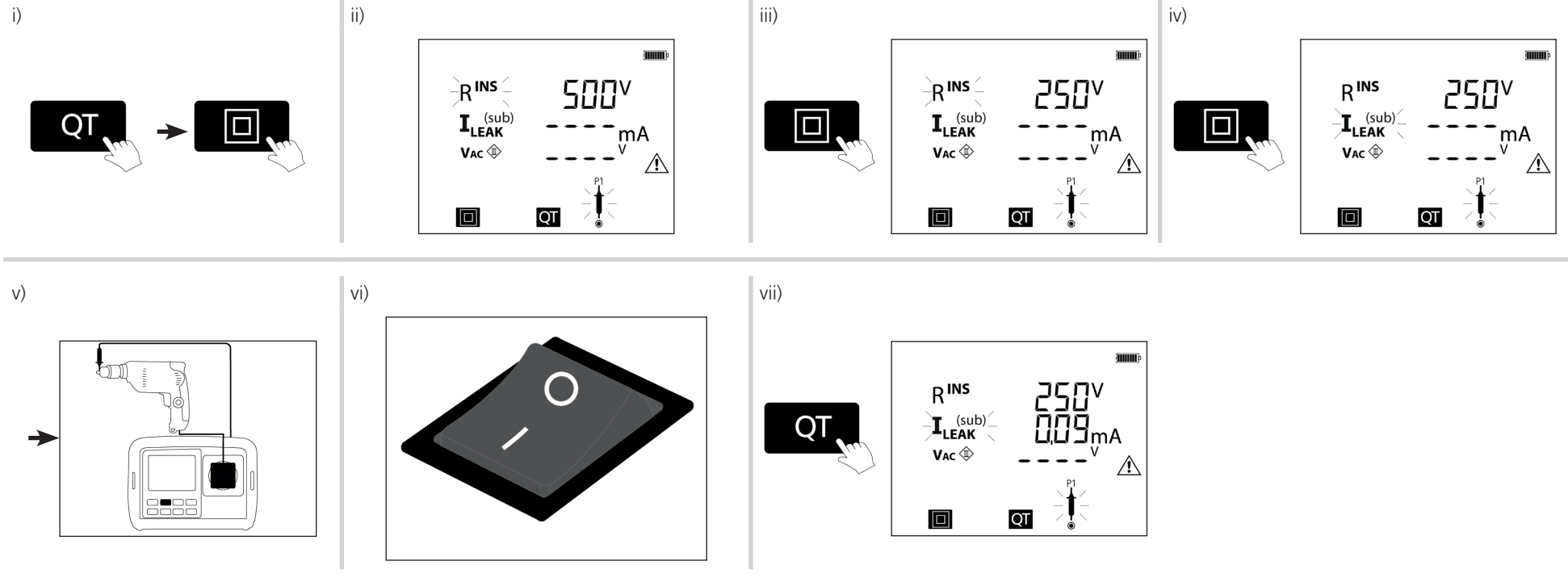

To repeat test 

**NOTE :** To switch between test groups, press the test group buttons.

To exit press the ON/OFF button



## SELV measurement within Quick Test (QT)

Separated Extra Low Voltage (SELV) measurement is performed automatically when the PAT150 is connected to the electrical supply

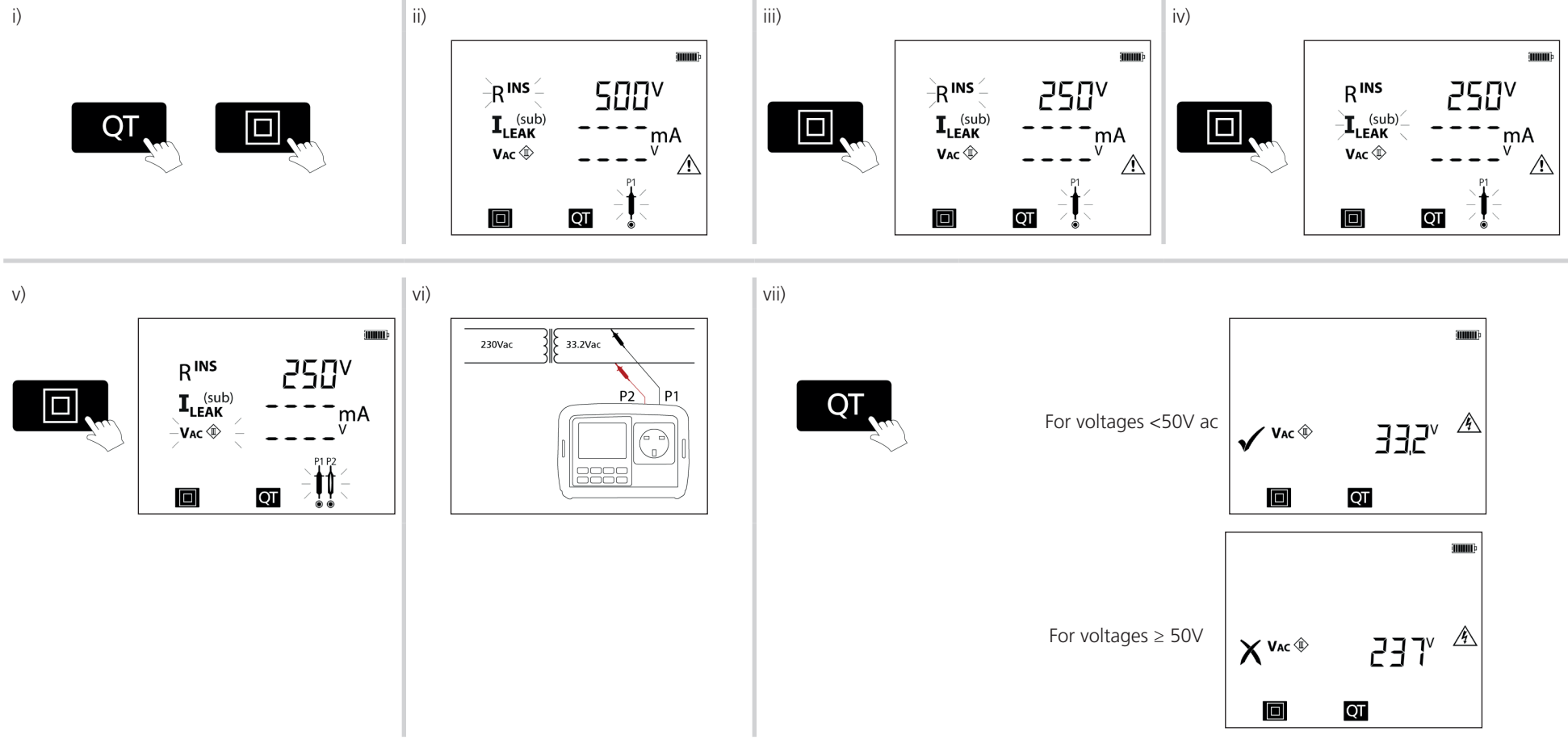

To exit Quick Test (QT) mode 



## SETUP (PAT150, 150R)

Changing PASS limits and test times

i)

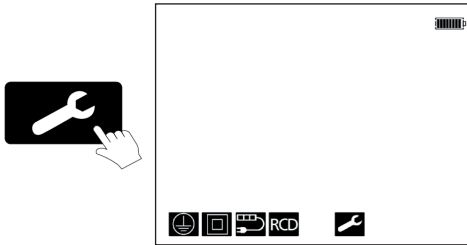

ii)

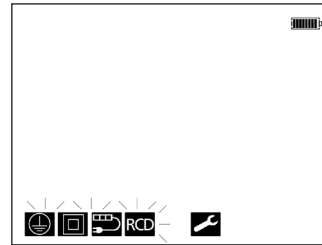

iii) To select a TEST GROUP to be modified press the relevant button:

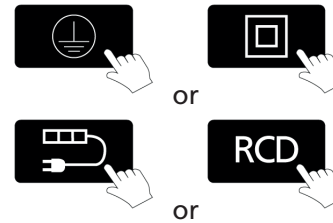

iv) Screen displayed

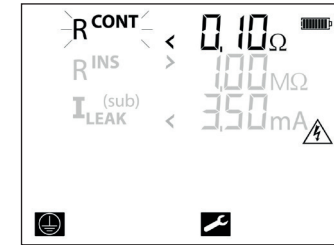

v) Keep pressing the TEST GROUP button to select the test to be changed



Pass Limit	
Default	Rcont 0.01 Ω
1st press	Rins 1.00 MΩ
2nd press	I leak 3.50 mA
Test Time	
3rd press	Rcont 5: S
4th press	Rins 5: S
5th press	I leak 5: S

vi) Example changing Insulation pass limit

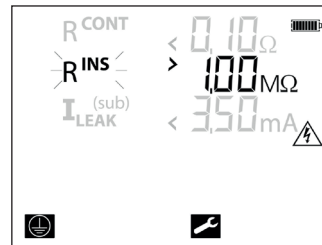

vii) Pressing SETUP button changes the value



Default	1.00 MΩ
1st press	2.00 MΩ
2nd press	0.01 MΩ
3rd press	0.05 MΩ
4th press	0.25 MΩ
5th press	0.30 MΩ
6th press	0.50 MΩ

viii) Example: Rins change to 2.00 MΩ

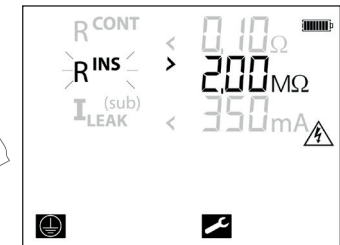

Note : Pressing QT changes the direction

ix) To SAVE changes to setup



x) or, to edit new test groups

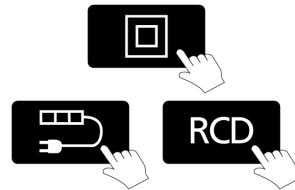

xi) When changes are complete press the Power button





## Continuity lead null

Removes the resistance of the CONTINUITY test leads from the measured value

To NULL the resistance of the IEC test lead or an extension lead

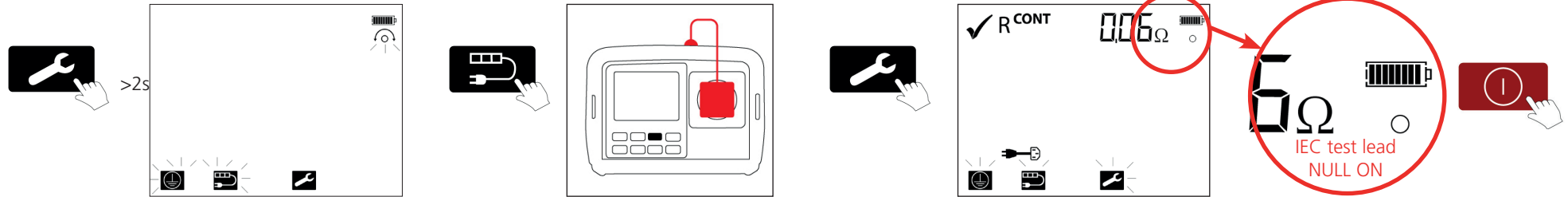

To remove the lead null

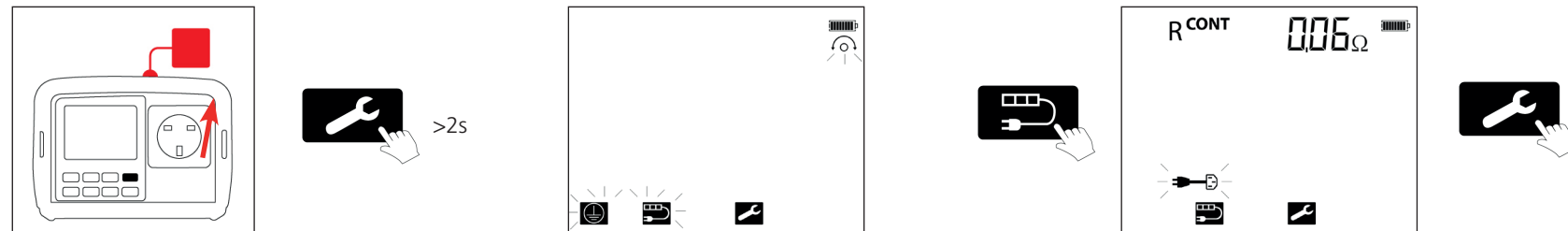

To NULL the resistance of the P1 continuity test lead

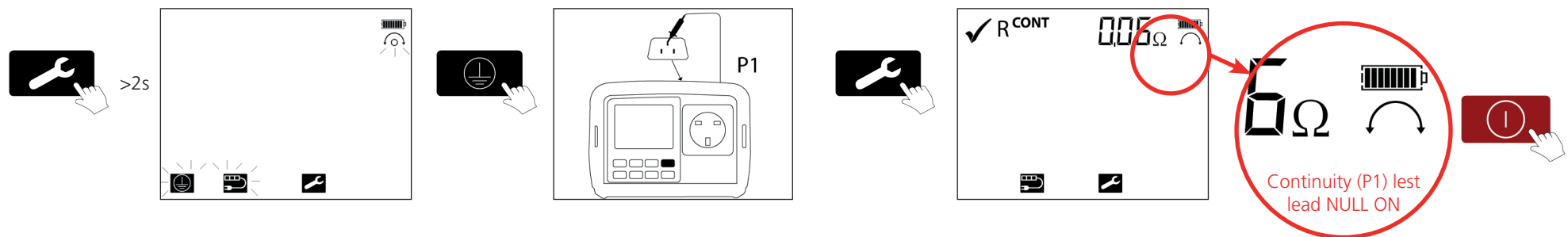

To exit Lead null setup 

## RCD configuration

Portable RCD current rating can be changed between 10 mA and 30 mA

Portable RCD trip time for 30 mA can be set at either 200 ms (for BS 7071 conformity) or 300 ms (for IEC 61540 conformity)

### Portable RCD trip current selection

i)



ii)

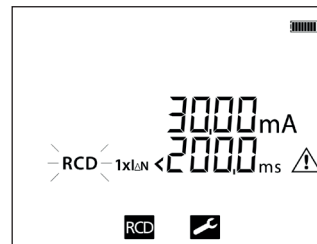

iii) Press RCD button to change from 30 mA to 10 mA

For 10mA RCD



To change trip time



iv)

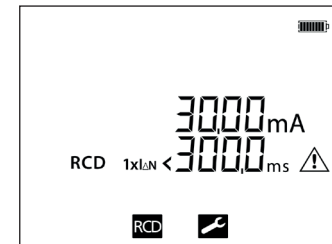
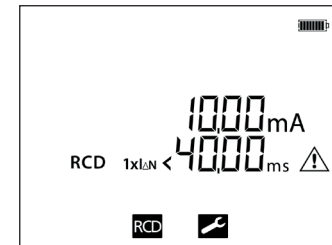

To exit RCD configuration



## Factory reset to Default settings

### Factory default settings

SETUP - change test pass limits, test times and test lead resistance. SETUP is "test group based" as the PASS limit for a Class I insulation test is different to a Class II insulation test.

### Factory Default Test Limits

Variant Model	R <sub>PE</sub> , R <sub>CONT</sub> (Ω)	R <sub>PE</sub> , R <sub>CONT</sub> (Ω) for Ext lead	R <sub>PE</sub> , R <sub>CONT</sub> (Ω) for RCD	Class 1 R <sub>ISO</sub> , R <sub>INS</sub> (MΩ)	Class 2 R <sub>ISO</sub> , R <sub>INS</sub> (MΩ)	Ext lead R <sub>ISO</sub> , R <sub>INS</sub> (MΩ)	Class 1 I <sub>EA</sub> , I <sub>LEAK(sub)</sub> , I <sub>PE</sub> , I <sub>LEAK</sub> (mA)	I <sub>t</sub> , I <sub>B</sub> Class 2 I <sub>EA</sub> , I <sub>t(sub)</sub> (mA)	1xIΔN30 (ms)	5xIΔN30 (ms)	1xIΔN10 (ms)	5xIΔN10 (ms)
PAT120-UK	0.2	0.2	0.2	1	2	1	3.5	0.25	NA	NA	NA	NA
PAT150-UK	0.2	0.2	0.2	1	2	1	3.5	0.25	200	40	200	40
PAT120-DE, PAT120-CH, PAT120-EU	0.3	0.3	0.3	1	2	1	3.5	0.5	NA	NA	NA	NA
PAT150-DE, PAT150-CH, PAT150-EU	0.3	0.3	0.3	1	2	1	3.5	0.5	300	NA	300	NA
PAT150-AU	1	1	1	1	1	1	5	1	300	NA	40	NA



## Region selection

i) To return an instrument to Factory Default settings:

Press  +  together for 2 seconds

ii)

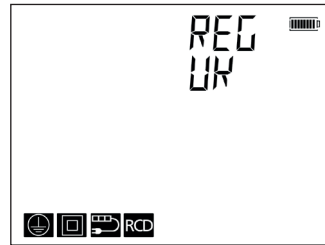

iii)



iv)

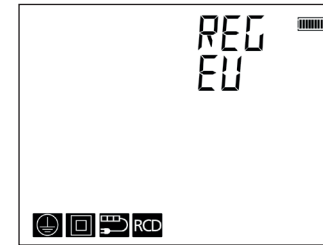

v)

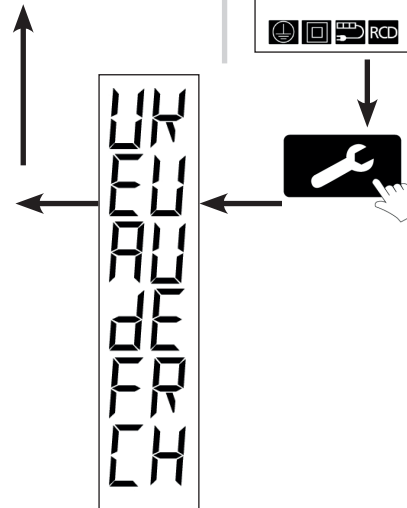

## International model variations:

### Continuity retest after fail (PAT120, PAT150 DE, & CH models only)

When a continuity test fails to meet the pre-set continuity resistance pass limit of  $0.3 \Omega$ , the test can be run again within 5 seconds at the higher  $1.0 \Omega$  limit.

Example Class I continuity FAIL. Display shows:

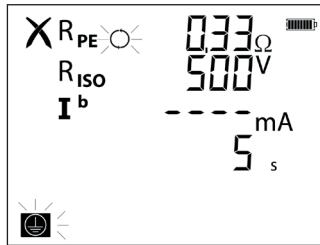

to retest at  $1.0 \Omega$  limit or



to FAIL test

## Battery and Fuse replacement (PAT120, 150)

Battery type: 8 x 1.5 V Alkaline LR6 (AA) or NiMH HR6 rechargeable

Battery condition is shown by the following display symbols:

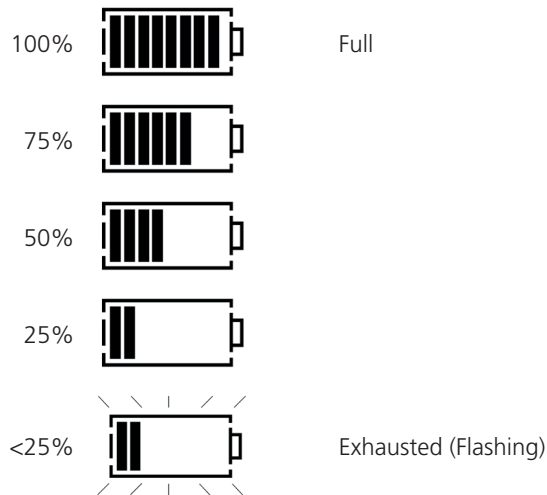

To replace batteries or fuse:

Switch off the instrument.

Disconnect the instrument from all electrical circuits.

### Battery replacement

Remove the battery cover from the base by using a cross head screwdriver to unscrew the battery cover fixing screw.

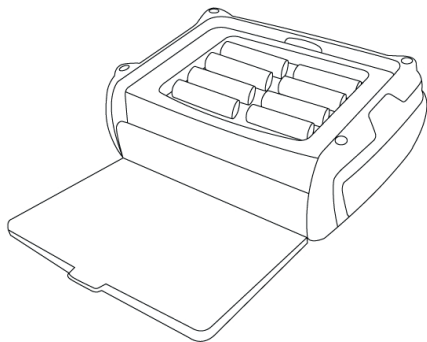

Spent Alkaline and NiMH batteries are classified as portable batteries and should be disposed of in the UK in accordance with Local Authority requirements. For disposal of batteries in other parts of the EU contact your local distributor.

Megger is registered in the UK as a producer of batteries.

The Registration number is BPRN 00142

### For battery replacement:

a) Remove old cells and refit new batteries following correct polarity as marked on the battery holder.

Either: 8 x 1.5 V AA / LR6 Alkaline  
8 x 1.2 V AA / LR6 NiMH

c) Replace the battery cover.

**Warning:** Incorrect battery cell polarity can cause electrolyte leakage, resulting in damage to the instrument.

**Warning:** Do not mix battery technologies

**Warning:** Do not use batteries with different charge state.

### ⚠ Rechargeable batteries and battery charging

All PAT100 series accept alkaline or rechargeable NiMH cells. Only the PAT150R can be recharged as below:

PAT150R – Use supplied battery charger

### To charge the batteries:

Ensure fitted batteries are of the rechargeable NiMH type.

Connect the 15 V DC plug of the charger to the socket on the connection panel of the PAT

marked .

**Warning:** The instrument should be fully disconnected and not used during the charging process.

**Warning:** Do not attempt to recharge non-rechargeable (Primary) cells. Doing so may result in instrument damage and may cause personal injury.

**Warning:** Only use a Megger approved PAT100 charger. Other chargers may present a fire risk.

Ensure ambient temperatures are between 4 °C and 40 °C while charging the PAT.





## Battery Disposal

The crossed out wheeled bin symbol placed on the batteries is a reminder not to dispose of them with general waste at the end of their life.

This product contains the following batteries:

8 x AA Alkaline (LR6) 1.5V primary cells or

Nickel Metal Hydride NiMH (HR6) 1.2V secondary cells

They are located in the battery compartment on the rear of the instrument

They can be safely removed by ensuring all test leads have been disconnected from the instrument prior to removing the battery cover with a suitable screwdriver.

Spent PAT100 batteries are classified as Portable Batteries and should be disposed of in the UK in accordance with Local Authority requirements

For disposal of batteries in other parts of the EU contact your local Megger company or distributor.

Megger is registered in the UK as a producer of batteries.  
The Registration number is BPRN00142

For Further information see [www.megger.com](http://www.megger.com)

## Fuse replacement

Possible fuse failure is indicated by the symbol. 

### For fuse replacement

Remove battery cover as above.

Withdraw fuse and check for failure.

Replace with a fuse type:

1 x 100 mA (F) 250 V 1.5 KA HBC 4 x 20 mm



## Preventive maintenance

Test leads should be checked before use to ensure there is no damage.

Ensure batteries are removed if the instrument is left unused for an extended period.

When necessary, the instrument can be cleaned with a damp cloth.

Do not use alcohol based cleaners as these may leave a residue.

## Deceleration of Conformity

Hereby, Megger Instruments Limited declares that radio equipment manufactured by Megger Instruments Limited described in this user guide is in compliance with Directive 2014/53/EU. Other equipment manufactured by Megger Instruments Limited described in this user guide is in compliance with Directives 2014/30/EU and 2014/35/EU where they apply.

The full text of Megger Instruments EU declarations of conformity are available at the following internet address: [megger.com/eu-dofc](http://megger.com/eu-dofc).

## Specification

### ENVIRONMENTAL CONDITION:

Operating ambient 20°C  
Humidity Nominal humidity

### CONTINUITY TEST

Test voltage Compliance Voltage: +4 V dc  
-0% / +10% (open circuit)  
Test current Bi-directional +200 mA  
-0% + 50 mA (into 2 Ω load)  
Continuity accuracy Resistance: ± 5% ± 3 digits (0 to 19.99 Ω)  
Resistance resolution 10 mΩ  
Display range 0.01 to 19.99Ω  
Continuity test nulling up to 9.99 Ω  
Test time User selectable from 2 sec to 20 sec or selected during test to 180 sec

### INSULATION TEST

Insulation test 250 V dc -0 % /+25 % open circuit  
500 V dc -0 % /+25 % open circuit  
Short circuit/charge current ≥ 500V -0% dc across 0.5 MΩ load  
Insulation accuracy < 2 mA dc  
Resolution ±3% ±10 digits (0 to 19.99 MΩ)  
0.01 MΩ  
Display range 0.10 MΩ to 99.99 MΩ  
Test duration User selectable from 2 sec to 20 sec or selected during test to 180sec

### SUBSTITUTE LEAKAGE TEST

Leakage current Accuracy ± 5% ± 3 digits  
Test frequency Nominal mains frequency 50Hz  
Test voltage < 50 V ac  
Leakage Current Resolution 0.01 mA  
Display range 0.10 to 19.99 mA  
Test duration User selectable from 2 sec to 5 seconds  
Reading corrected to 230V ac.

### DIFFERENTIAL LEAKAGE CURRENT

Test voltage Nominal supply voltage 230 V ac  
Test frequency Nominal mains frequency 50 Hz  
Test accuracy ±5% ±3d ±3uA/A  
Resolution 0.01 mA  
Display range 0.10 to 19.99 mA  
Test duration User selectable from 2 sec to 5 seconds

### TOUCH CURRENT TEST

Test voltage Nominal mains 230 V ac  
Test frequency Nominal mains 50 Hz  
Test accuracy ± 5% ± 3 digits  
Resolution 0.01 mA  
Display range 0.10 to 3.99 mA  
Test duration User selectable from 2 sec to 5 sec

### SELV DEVICE TEST

Test voltage 0 to 300 V ac  
Measurement accuracy ± 3% ± 3 digits  
Resolution 0.1 V ac  
Display range 0.1 to 300 V ac

### EXTENSION LEAD TEST

Test includes Insulation and Bond tests.  
Test voltage 5 V  
Polarity Lead OK  
Live neutral shorted  
Live neutral reversed  
Live/neutral open circuit

### PORTABLE RCD TEST

Test voltage Nominal mains 230 V  
Test frequency 50 Hz  
Test current accuracy +2% to +8% (1 x I, 5 x I)  
Trip time accuracy ±1% ± 1 ms  
Trip time resolution 0.01 ms  
Display range 0 to 200 ms (1 x I)  
0 to 40 ms (5 x I)

### MAINS SUPPLY TEST



## Specification

Frequency measurement range	50 Hz
Test voltage	40 to 300 V ac
Accuracy	± 3% ± 3 digits
Resolution	0.1 V ac
Display range	40 to 300 V ac

## CIRCUIT TEST

**(Carried out automatically, not available to user)**

Test voltage	5 V
Test frequency	Nominal Mains 50 Hz
Test current	< 100 mA short circuit

## SAFETY

Instrument designed to IEC 61010-1: 2010  
 Test leads designed to IEC 61010-031: 2008  
 300 volts to Earth Category II  
 Mains fuse protection to 250 volts rms ac

## EMC

Design to meet IEC 61326-1: 2012 and IEC 61326-2-2: 2005.

## FUSE

(user replaceable)  
 UK variants has mains plug fuse  
 One F 100 mA 250 V 5 x 20 mm HBC fuse.

## ENVIRONMENTAL

Operating temperature range	0°C to +40°C
Storage temperature range	-20°C to +60°C
Humidity	90%RH @ +10°C +30°C 75%RH @ +30°C to +40°C
Maximum altitude	2,000m to full safety spec.
IP rating	IP40 (with front cover closed)

## MECHANICAL

### BATTERIES

Battery life	> 30 hrs 20sec:2min Test:Standby ratio
Battery type	Supply voltage 12 Vdc (Alkaline AA LR6) 9.6 Vdc (NiMH AA LR6)

### WEIGHT

PAT120 (instrument only):	1150 g	(40.4 oz)
Shipping weight:	2370g	(83.6 oz)
PAT150 (instrument only):	1300 g	(45.8 oz)
Shipping weight:	2795g	(98.6 oz)
PAT150R (instrument only):	1300 g	(45.8 oz)
Shipping weight:	2975g	(104.9 oz)

### DIMENSIONS

Dimensions (instrument and case)	203 mm (L) x 148 mm (W) x 78 mm (H) (8 x 5.7 x 3.2 inches)
Dimensions (instrument and packaging)	456 mm (L) x 178 mm (W) x 89 mm (H) (18 x 7.1 x 3.5 inches)



**Megger Limited**  
Archcliffe Road, Dover  
Kent CT17 9EN England  
T +44 (0)1 304 502101  
F +44 (0)1 304 207342  
E [uksales@megger.com](mailto:uksales@megger.com)

**Megger**  
Z.A. Du Buisson de la Couldre  
23 rue Eugène Henaff  
78190 TRAPPES France  
T +33 (0)1 30.16.08.90  
F +33 (0)1 34.61.23.77  
E [infos@megger.com](mailto:infos@megger.com)

**Megger Pty Limited**  
Unit 26 9 Hudson Avenue  
Castle Hill  
Sydney NSW 2125 Australia  
T +61 (0)2 9659 2005  
F +61 (0)2 9659 2201  
E [ausales@megger.com](mailto:ausales@megger.com)

**Megger**  
4271 Bronze Way  
Dallas  
TX 75237-1017 U.S.A.  
Tel: +1 (800) 723-2861 (U.S.A. only)  
Tel: +1 (214) 330-3203 (International)  
Fax: +1 (214) 337-3038

**Megger**  
Valley Forge Corporate Centre  
2621 Van Buren Avenue  
Norristown, PA 19403, USA  
Tel: +1 (610) 676-8500  
Fax: +1 (610) 676-8610

**Megger GmbH**  
Obere Zeil 2  
61440 Oberursel  
Germany  
T 06171-92987-0  
F 06171-92987-19

This instrument is manufactured in the United Kingdom.  
The company reserves the right to change the specification or design without prior notice.

Megger is a registered trademark

Part No. PAT100\_UG\_EN\_V04 07/2016

[www.megger.com](http://www.megger.com)