



# **Portable Appliance Tester** **PAT2**

*Operating  
Instructions*

**MEGGER<sup>®</sup>**

# Contents

---

Safety Warning	2
General Description	4
Applications $\Delta$	5
Specification	8
Operation	9
Warning	9
The detachable lid	9
General information	9
Preliminary procedure	10
Appliance testing procedure $\Delta$	10
Resistance of supply leads	15
Operating Instructions in French	16
Operating Instructions in German	20
Operating Instructions in Spanish	24
Circuit Description	28
Setting-Up Procedure	30
Accessories	31
Instrument Repairs and Spare Parts	32
Components List	33
Circuit Diagrams	34

# General Description

The Portable Appliance Tester PAT2 is a very robust and reliable instrument, built into a strong plastic case with a moulded carrying handle and a hinged detachable lid. Fitted to the lid is an accessory pouch containing the test leads and probes.

The basic instrument, which operates from a 240 V 50 Hz mains power supply will perform five tests on an appliance.

These tests are:-

- Earth Bond, Test 1
- Insulation  $\overline{\sim}$ , Test 2
- Flash  $\sim$ , Test 3
- Load, Test 4
- Operation, Test 5

There are various versions of the PAT2 designed for use with the different supply voltages found in many parts of the world. They all perform the same tests as the basic instrument and the construction is similar, except that the appliance socket fitted in the front panel is one which is commonly found in the 'territory of use' of that particular version. Also the front panel is marked in an appropriate language and a specific model number is assigned to each version. The table opposite gives details of the variations.

The tester is simple to use and the number of connections required to perform a test sequence has been kept to a minimum. Apart from connecting the tester to a mains supply and plugging the appliance to be tested into the three pin socket on the front panel, the only additional connections necessary are an earth bond lead for 'earthed' appliances and a probe for insulation and flash testing double insulated appliances.

Model number	Territory of use	Nominal mains supply voltage	Appliance connecting socket fitted	Graphics language
PAT2 UK240	United Kingdom	240 V 50 Hz	BS1363 13 Amp	English
PAT2 UK110	United Kingdom	110 V 50 Hz	BS4343.CEE 17	English
PAT2 NA120	Canada and USA	120 V 60 Hz	ANSI	English
PAT2 EUR220	Finland, Netherlands, Portugal, Spain, Sweden	220 V 50 Hz	CEE7 Sheet IV	English
PAT2 UK220	Republic of Ireland	220 V 50 Hz	BS1363 13 Amp	English
PAT2 F220	France and Belgium	220 V 50 Hz	CEE7 Sheet VI	French
PAT2 NZ230	New Zealand	230 V 50 Hz	AS C112 10 Amp	English
PAT2 UK230	Nigeria, India, Bahrain, Abu Dhabi, Pakistan, Singapore	230 V 50 Hz	BS 13 Amp (Flat pin)	English
PAT2 SA230	South Africa	230 V 50 Hz	BS 15 Amp	English
PAT2 AUS240	Australia	240 V 50 Hz	AS C112 10 Amp	English

The rotary switch is used to select each of the test functions in turn. A push-button is pressed to energize the instrument and make a test, and an indicating neon light glows when a test is being performed. The readings from each test are shown on an analogue panel meter, the scales of which are marked with a green "pass band" as well as the calibration. This assists in quick identification of a successful test as well as giving actual test measurements.

The meter has a "live zero" for the Earth Bond, Insulation and Flash tests. That is, there is a difference between the mechanical zero and the electrical zero, this therefore provides a visible indication that the test voltage is present and the reading valid. As far as the measurement is concerned the electrical zero is the true zero point (infinity point on the insulation test).

# Applications

The circuit incorporates a breaker, with a re-set button on the front panel, that gives protection to the appliance (and the tester) if heavy currents are drawn during the 'Operation' test. The circuit has been designed with "built-in" protection for the instrument, and in such a way that the output for each function is kept to a minimum for safety.

The PAT2 is used to check the electrical safety of portable appliances. The tests are simply carried out and the instrument is very easy to operate.

Appliances with Safety Class 1 and Safety Class 2 insulation may be checked.

These classes of safety are defined in various IEC and BS safety specifications and generally are:-

- Class 1 appliances which have a functional insulation throughout and an earth connected case, i.e. *earthed appliances*.
- Class 2 appliances which have both functional and additional insulation and where any metal parts cannot become 'live' under fault conditions. This is *double insulation*, symbol mark  $\square$ , and in this type of appliance there is no earth connection.
- Class 1/2 appliances having part of the enclosure which meets Class 1 requirements and part which meets Class 2.

Whilst the tester will perform the standard electrical safety tests, it will not however meet the *full* accuracy requirements of standard specifications. (To do so would require a much more sophisticated and expensive tester which might probably also be much less robust).

The tests performed on appliances are as follows:-

**Earth Bond, Test 1** – This is for testing the earth lead continuity and earth connection (or bonding) to the metal casing of an appliance. A voltage (6 V a.c. r.m.s. on open circuit) is established between the appliance mains supply plug earth pin and the appliance case. The design is such

# Applications

that the current flowing meets approximately BS and IEC specifications, i.e. 25 A at 0,1  $\Omega$  and 10 A at 0,5  $\Omega$ . (For the PAT2 the figures are approximately 26 A and 10 A respectively.) The current is intended to fuse weak joints and hence, where light duty cables are used for loads normally less than 5 A, the cables must not be stressed with this current too frequently or for too long, (not less than monthly and not more than 5 seconds).

This test is only required on earthed appliances (Class 1).

**Insulation  $\sim$ , Test 2** – 500 V is the standard test voltage specified by BS and IEC, however, the open circuit voltage of the PAT2 on this test, is approximately 600 V falling to 500 V when loaded with 2 M $\Omega$  at the 'pass-band' limit. (Various specifications call for a different limit but 2M $\Omega$  is a general figure).

The test voltage is applied between the portable appliance mains supply plug P (phase), [also referred to as L (line)], and N (neutral) pins connected together, and the E (earth) pin which is held at earth potential. The test probe socket (marked 'Insulation/Flash Probe') is also connected to the E pin. The P (L) + N pins are negative with respect to earth.

**Flash  $\sim$ , Test 3** – There are numerous test voltages required by BS and IEC specifications.

For example, for double insulated appliances, flash test voltages of 2,5 kV to 4 kV are required. Regular stressing at 4 kV will weaken the appliance and is thought necessary to be used only for approval tests, and not routine maintenance.

The PAT2 provides the generally accepted standard in the IEC for instrument flash tests, namely 1,5 kV for earthed

appliances (single insulation) and 3 kV for double insulated appliances. The short circuit current is limited to 6 mA from both outputs.

The 1,5 kV test voltage is injected between the appliance mains supply plug P (L) and N pins connected together and the E pin which is held at earth potential. The test probe socket (marked 'Insulation/Flash Probe') is at 3 kV with respect to the P (L) and N pins connected together.

The level of leakage current can be measured.

**⚠ Load, Test 4** – In this test the appliance is supplied from 6 V a.c. (via its three pin mains supply plug). This low voltage load test enables the appliance to be assessed under load conditions without the problems that might arise if the full operating voltage were used as in Test 5. That is, the drawing of high current under a fault condition. If the meter reading is in the green band on scale 4 all is well. The upper limit of the green band implies the condition of a current of 13 A flowing at nominally supply voltage. If the reading obtained is in the red band a fault is present which under a normal operating voltage will cause a very heavy current (>60 A) to flow. Test 5 should not be carried out without investigation to ascertain the cause of the fault.

If the appliance has an inductive stalled motor, then the winding may appear as a short circuit at this voltage, and this test may be omitted.

**Operation, Test 5** – This test simply connects the mains supply to the appliance under test, (via its three pin mains supply plug), and measures the load current. A 6 A circuit breaker gives protection against overloads. This acts in milli-seconds for short circuit conditions but remains for a few seconds at, say 13 A in order that readings can be

---

taken. The readings are in kVA assuming the supply voltage is at the nominal value. The load current can be found by dividing the reading by the nominal voltage. The reading should be compared with the appliance rating. However, in certain cases, such as electric drills, the rating stated is usually for the appliance when under load conditions and this must be taken into account.

For safety the tests must be performed in the order 1 to 5 for earthed appliances and 2 to 5 for double insulated appliances. For tests 2 to 5 the appliance "on/off" control switch must be in the "on" position.

⚠ It is most important that the tests are performed in the correct sequence and that if any fault in an appliance is discovered, testing is stopped and the fault corrected. Testing should then re-commence from the start, i.e. Test 1 for earthed appliances and Test 2 for double insulated appliances.

If an earth bond fault is found it is possible that any metal parts of the appliance could rise to a dangerous voltage, especially if an insulation test or a flash test is performed. If an insulation test or a flash test fail, there is a leakage path to earth somewhere on the appliance and this is likely to produce an electric shock to the operator. A failure of the load test implies that under full operation a high current might flow. This would also inevitably cause damage both to the appliance and the appliance tester, and also put an operator at risk because of other effects which a high current would produce, e.g. sparking as electrical contacts are made.

# Specification

<p><b>Tests Available</b></p> <p>Earth Bond, Test 1 Insulation <math>\overline{\sim}</math>, Test 2 Flash <math>\sim</math>, Test 3 Load, Test 4 Operation, Test 5</p> <p><b>Earth Bond Test</b></p> <p><b>meter reading range</b> 0 to 0,5 <math>\Omega</math> (forward reciprocal scale) <b>pass band limit</b> 0,1 <math>\Omega</math> +0 -0,01 <math>\Omega</math> <b>open circuit voltage</b> 6 V a.c. r.m.s. (nominal) <b>short circuit current</b> 37,9 A (nominal) (at 0,1 <math>\Omega</math> current is 26,2 A nominal, at 0,5 <math>\Omega</math> current is 9,6 A nominal)</p> <p><b>Insulation <math>\overline{\sim}</math> Test</b></p> <p><b>meter reading range</b> 0,75 M<math>\Omega</math> to 20 M<math>\Omega</math> (reverse reciprocal scale) <b>pass band limit</b> 2 M<math>\Omega</math> + 0,2 M<math>\Omega</math> -0 <b>open circuit voltage</b> 600 V d.c. (nominal) (at 2 M<math>\Omega</math> voltage is 500 V d.c. nominal) <b>short circuit current</b> 2 mA (nominal)</p> <p><b>Flash <math>\sim</math> Test</b></p> <p><b>meter reading range</b> 0 to 6 mA (linear scale) <b>pass band limit</b> 3 mA (nominal) <b>open circuit voltage</b> 1,5 kV a.c. r.m.s. (nominal) for Class 1 3 kV a.c. r.m.s. (nominal) for Class 2 <b>short circuit current</b> 6 mA (nominal) for Class 1 6 mA (nominal) for Class 2</p> <p><b>Load Test</b></p> <p><b>meter reading range</b> green/white/red arc <b>pass band</b> green <b>open circuit voltage</b> 6 V a.c. r.m.s. (nominal) <b>short circuit current</b> 330 mA (nominal for 220 V-240 V supply) 660 mA (nominal for 110 V-120 V supply)</p>	<p><b>Operation Test</b></p> <p><b>meter reading range</b> 0 to 3,5 kVA (linear scale)</p> <p><b>Supply Voltage</b> mains power supply - dependent upon model - (see page 4), supply voltage variation <math>\pm 6\%</math>. All open circuit voltages, set point currents and meter deflections are directly proportionally affected by the supply voltage.</p> <p><b>Safety Class</b> Class 1/Class 2 (IEC 414 Ed.1 1973) (The metal front panel is earthed and is to Class 1. The plastic case is to Class 2).</p> <p><b>Dimensions</b> 344 x 245 x 200 mm (13,5 x 9,6 x 7,9 in)</p> <p><b>Weight</b> 6 kg approx. (13,25 lb)</p>
---	--

# Operation

## WARNING

The user of this instrument must ensure that the appliance to be tested is in a safe state both electrically and mechanically, so that no hazard will be presented to himself or to any other person if, while being tested, the appliance operates as a result of a fault condition or the normal running condition.

Do not use dirty or damaged test probes and leads. Maintain these in a good clean condition. Hold the probes by their handles and away from the tip.

For safety the PAT2 must be properly earthed. Check this by performing an Earth Bond Test with the probe connected to the mains supply earth and obtaining a reading of  $<0,5 \Omega$ .



Do not touch appliances while they are under test. The instrument generates '+ ' and '- ' 1,5 kV with respect to earth, during flash testing. These dangerous voltages will exist on an appliance being tested. Under fault conditions, physical contact with the insulation of that appliance may give an electric shock. (Similarly, during insulation testing the appliance is subjected to 600V).

**The 'TEST' push-button must be released before the selector switch is changed to another position.**

**For safety, tests must be performed in the order Test 1, Test 2, Test 3, Test 4, Test 5 (see 'General Information' opposite). If an appliance fails a test, the fault causing the failure MUST be corrected before any further tests are made.**

In cases where appliances contain interference suppressors, the 'Flash ~ Test 3' may need to be omitted,

if the voltage withstand rating of the components fitted is not high enough.

In cases where appliances have light duty cables i.e. 5 A, the 'Earth Bond Test 1' should not be prolonged (5 s maximum) or repeated frequently (no more than monthly).

The circuit breaker (mounted on the front panel) should not be used as an on/off switch. To do so will reduce its working life and hence its reliability. Only in an emergency, e.g. if the 'TEST' push-button fails to switch off when it is released, the circuit breaker may be used instead.

## THE DETACHABLE LID

The lid hinges are fitted with spring loaded clips and are designed in this way for two reasons. Firstly, if the lid is accidentally thrown open to its full extent, the hinges will not be strained or broken but the lid will be safely unclipped. Secondly, the lid can purposely be removed, if required, when the tester is in use by simply opening it up to its full extent and gently pressing down on the opening edge while holding the tester body firm. The hinges will then unclip.

To replace the lid simply hold it vertically and push the hinges back into their clips again; then fold the lid shut.

Note:- The mains supply lead for the tester is stored under the closed lid. Where possible coil the lead around on top of the control panel and insert the mains supply plug into the socket on the panel. (When this is not possible, as in the PAT2 UK110 version, the lead may be coiled as before and the supply plug stored in the accessory pouch).

## GENERAL INFORMATION

For earthed appliances, i.e. those designated Class 1 appliances, testing should commence with the 'Earth Bond, Test 1'.



# Operation

For double insulated appliances, i.e. those designated Class 2 appliances, (symbol mark  $\square$ ), testing should commence with the 'Insulation  $\infty$ ', Test 2'.

Tests should be performed with the appliance switched on! If it is found, when 'Operation, Test 5' is performed that the appliance does not operate, and that this is because it was not switched on or its supply line fuse had ruptured, then the test procedure should be repeated from the start in the correct manner.

A test is performed only when the 'TEST' push-button is pressed, and a neon light illuminates to show when this happens.

To pass a test, appliances should give readings within the green 'pass band' on the meter scale, unless their specification dictates otherwise.

A 6 A circuit breaker gives protection against heavy fault current conditions in the appliance under test yet will allow time for a reading to be taken before tripping off. A thermal switch also gives protection during prolonged use of the Earth Bond test. If the 'TEST' push-button has no effect wait a few moments for the instrument to cool.

The meter has a "live zero" for Test 1, Test 2 and Test 3. This indicates the presence of the test voltage when the tester is energized before the 'TEST' push-button is pressed.

Note:— A '0' reading will be shown on the meter if an Earth Bond test is made with the standard test lead connected directly to the 'earth' of the tester 3 pin socket. Similarly ' $\infty$ ' and '0' readings will be obtained for Insulation and Flash tests respectively if they are performed without making any connections.

## PRELIMINARY PROCEDURE

1. Ensure that the meter is set to the mechanical zero i.e. the extreme left hand graduation on the scale. The mechanical zero adjuster is located centrally below the meter scale and may be turned with a screwdriver.
2. Plug the appliance into the tester and switch the appliance on.
3. Plug the tester into the mains power supply and switch the supply on.
4. Ascertain the type of appliance to be tested, i.e. whether it is earthed or double insulated.  
For an earthed appliance start with the 'Earth Bond, Test 1'.  
For a double insulated appliance start with the 'Insulation  $\infty$ ', Test 2'.

## APPLIANCE TESTING PROCEDURE

### Earth Bond, Test 1 – see fig. 1

5. Turn the selector switch to 'Earth Bond, Test 1'.
6. Attach the Earth Bond lead hook connection to the 'Earth Bond' terminal on the front panel. Connect the crocodile clip to the appliance metalwork. If the alternative Earth Bond probe lead is used this is attached in the same way and the probe tip held in contact with the appliance metalwork.
7. Press the 'TEST' push-button and note the meter reading on the top scale marked  $\square$ . For a successful test the reading should be in the green "pass band", but the actual reading in ohms may be taken if necessary.  
The minimum reading that will be obtained is at the scale mark '0'. This is an electrically "live zero" as explained previously and shows that the test is valid (the test voltage having been applied).

TEST 1

25 A AT 0.1  $\Omega$

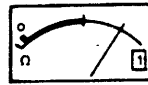
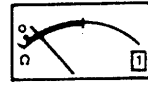
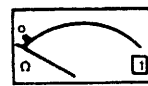
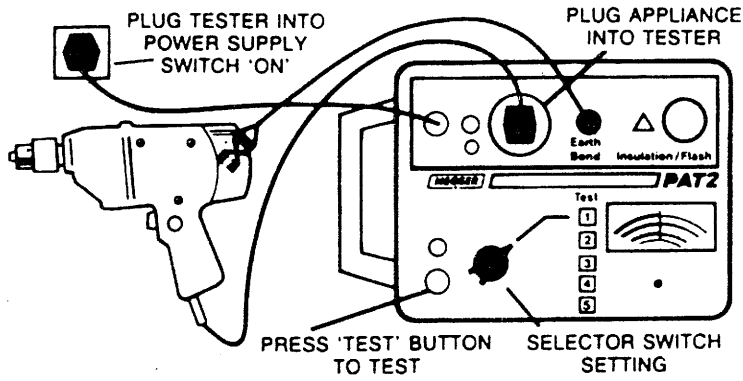
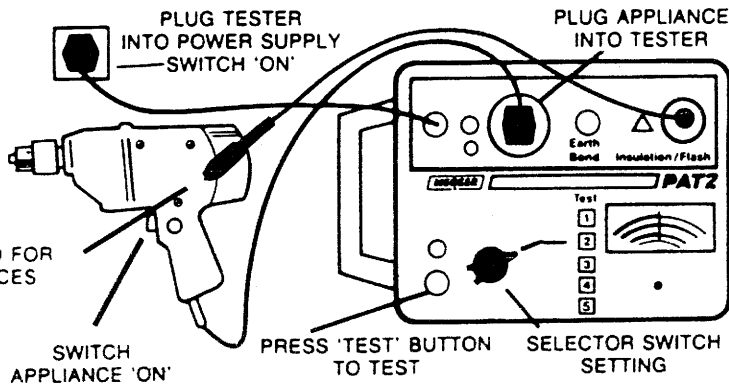

Fig. 1 : Earth Bond Test

TEST 2

500 V AT 2 M $\Omega$



PROBE NOT NEEDED FOR EARTHED APPLIANCES (I E CLASS 1)



Fig. 2 : Insulation Test

# Operation

Release the push-button and remove the Earth Bond lead.

- Note:— (i) If operating the push-button causes no reading on the meter and the tester has been used frequently or the previous test has been long, the thermal switch may have opened. Wait a few moments for the tester to cool and try again.
- (ii) Before the Earth Bond lead or probe is connected to the appliance under test, the meter should indicate f.s.d., or greater, with the 'TEST' push-button pressed.

## Insulation $\infty$ , Test 2 – see fig. 2

8. Turn the selector switch to 'Insulation  $\infty$ , Test 2'.
9. For double insulated appliances only. Plug the H.V. probe test lead into the 'Insulation/Flash Probe' socket, and apply the probe tip to the point of test on the appliance. (The probe has a sprung loaded protective head, so pressure must be exerted on the handle to force the tip out).  
For earthed appliances the test connections exist within the 3-pin socket between the earth, and phase (line) and neutral joined.
10. Press the 'TEST' push-button and note the meter reading on the second scale marked [2]. For a successful test the meter reading should be in the green 'pass band', but the actual reading in megohms may be taken if necessary.  
The maximum reading that will be obtained is at the scale ' $\infty$ ' mark. This is an electrically "live infinity" as explained above and shows that the test is valid (the test voltage having been applied).  
Release the push-button.

Note:— The test voltage on the internal smoothing capacitor will take 11 seconds to discharge. Suppressor capacitors in the appliance may extend this time by 5 seconds for every 0,1  $\mu$ F between earth, and phase (line) and neutral joined. Switching to the Flash Test will discharge any potential on the suppressor capacitors to a safe level at the rate of 1 second per 1  $\mu$ F max.

## Flash $\sim$ , Test 3 – see fig. 3

11. Turn the selector switch to 'Flash  $\sim$ , Test 3'. The connections remain as for the Insulation Test, i.e. as at (9) above.
12. Press the 'TEST' push-button and note the meter reading on the third scale marked [3]. For a successful test the meter reading should be in the green "pass band", but actual readings of leakage current in mA may be taken if necessary.  
The minimum reading that will be obtained is at the scale '0' mark. This is an electrically "live zero" as explained previously and shows that the test is valid (the test voltage having been applied).  
Release the push-button and remove the H.V. probe test lead (if used).

Note:— For earthed appliances the flash test is at 1,5 kV a.c. r.m.s. performed between the 3-pin socket earth, and phase (line) and neutral connections joined.  
For double insulated appliances the flash test is at 3 kV a.c. r.m.s. performed between the probe tip and the 3-pin socket phase (line) and neutral connections joined.

TEST 3

1,5 kV (Class 1)  
3 kV (Class 2)

PROBE NOT NEEDED FOR  
EARTHED APPLIANCES  
(I E CLASS 1)

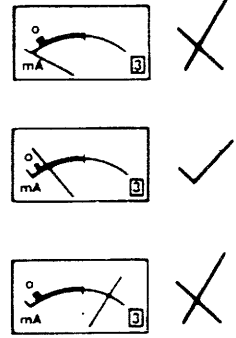
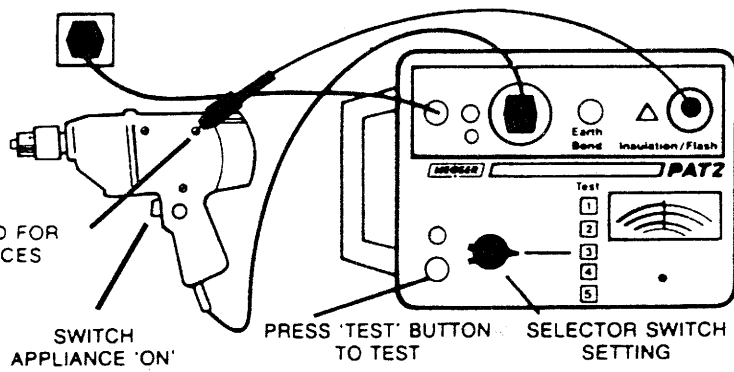

Fig. 3 : Flash ~ Test

TEST 4

6V ~

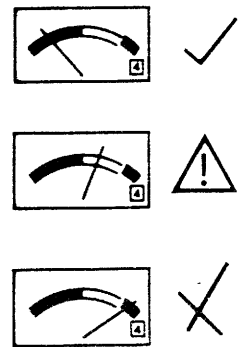
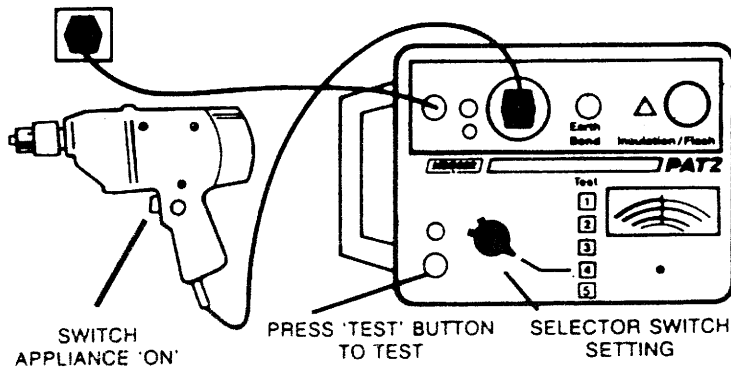

Fig. 4 : Load Test

# Operation

## Load, Test 4 – see fig. 4

13. Turn the selector switch to 'Load, Test 4'.
14. Press the 'Test' push-button. The appliance should not operate but the meter will give an indication on the green/white/red arc band [4]. A reading in the green band indicates a satisfactory result. A reading in the white band is generally not satisfactory unless the appliance under test is known to be an inductive stalled motor or cold high power lamp, in this case proceed with caution. If the meter pointer indicates in the red section then a serious fault exists which should be investigated before 'Test 5' is performed.

## Operation, Test 5 – see fig. 5

15. Turn the selector switch to 'Operation, Test 5'.
16. Press the 'TEST' push-button. The appliance will run
17. Release the push-button and disconnect the appliance.

and the load power being drawn will be shown on the meter in kVA. Load current can be calculated, if required, by dividing the meter reading by the supply voltage. The reading should be compared with the rating stated on the appliance. (Remember that with some appliances, e.g. electric drills, the rating given is under load conditions. In such cases the reading obtained will be less than that stated on the appliance.

Note:– The 6 A circuit breaker will allow at least 2 seconds for a reading to be taken for loads up to 13 A. Typical disconnection times for greater loads are: 0,2 second for 36 A and <0,01 second for 60 A. (The breaker is re-set simply by pressing the green push-button).

TEST 5

NORMAL RUNNING

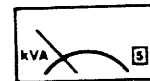
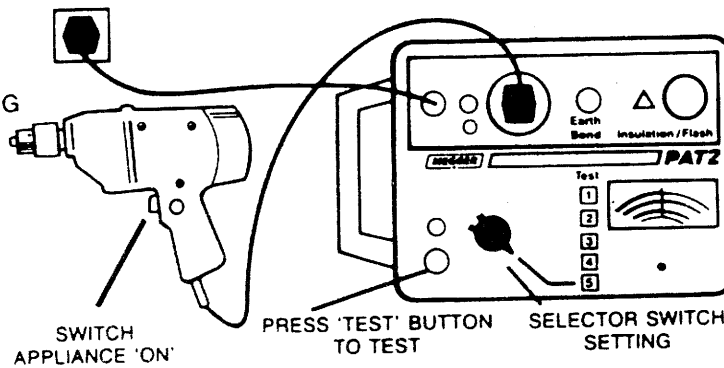

NOTE: COMPARE READING WITH APPLIANCE RATING. SEE INSTRUCTION BOOK

Fig. 5 : Operation Test

## RESISTANCE OF SUPPLY LEADS

Table of nominal resistances of appliance supply cable protective conductors (figures are for cables to BS 6500)

Nominal conductor c.s.a. mm <sup>2</sup>	Nominal conductor resistance mΩ/metre	Length metres	Resistance mΩ	Max. current carrying capacity A	Max. dia. of individual wire in conductor mm	Approx. no of wires in conductor	Nominal conductor c.s.a. mm <sup>2</sup>	Nominal conductor resistance mΩ/metre	Length metres	Resistance mΩ	Max. current carrying capacity A	Max. dia. of individual wire in conductor mm	Approx. no of wires in conductor
0,5	41,5	1	41,5	3	0,21	16	1,5	15,5	1	15,5	15	0,26	30
		1,5	62,25						1,5	23,25			
		2	83						2	31			
		2,5	103,75						2,5	38,75			
		3	124,5						3	46,5			
		4	166						4	62			
5	207,5	5	77,5										
0,75	28	1	28	6	0,21	24	2,5	9	1	9	20	0,26	50
		1,5	42						1,5	13,5			
		2	56						2	18			
		2,5	70						2,5	22,5			
		3	84						3	27			
		4	112						4	36			
5	140	5	45										
1,0	21,5	1	21,5	10	0,21	32	4	5,5	1	5,5	25	0,31	53
		1,5	32,25						1,5	8,25			
		2	43						2	11			
		2,5	53,75						2,5	13,75			
		3	64,5						3	16,5			
		4	86						4	22			
5	107,5	5	27,5										
1,25	17,5	1	17,5	13	0,26	24							
		1,5	26,25										
		2	35										
		2,5	43,75										
		3	52,5										
		4	70										
5	87,5												

The above table gives figures for the nominal resistance of the protective conductor per metre length and for various lengths of cable that may be fitted as supply leads to appliances. Having performed an Earth Bond Test the

approximate resistance of the protective conductor can be found and deducted from the test result to give a more realistic figure for the resistance of the earth bonding of the appliance.

## Circuit Description

(see the Circuit Diagram)

Each instrument function has its own totally passive circuit supplied from the mains power via a 6 A Thermo-magnetic breaker (CB1) and the 'TEST' push-button switch. With light overloads the circuit breaker trips off slowly under the influence of the thermal effect, allowing time for the meter to show the level of the overload. As the level of the overload increases the trip-off time reduces until with heavy overloads the magnetic control of the breaker brings about a rapid trip-off.

The output for the Earth Bond test is obtained from transformer T1 which is current limited by its own leakage inductance and resistance. The transformer secondary is joined to the 3-pin socket earth connection and the Earth Bond terminal on the front panel. The meter circuit, comprising of the meter, a swamp resistor and rectifier diode is connected to the same points, such that a four terminal measurement is made at the terminals. The resistance of the test lead (10 m $\Omega$  nominal) is included in the measurement circuit and provides the deflection to the "live zero" when the test lead is short-circuited directly between the Earth Bond terminal and the 3-pin socket earth connection. On open circuit the meter reads beyond f.s.d. Together these readings confirm that the instrument is functioning correctly on this test. A temperature controlled switch is included in the primary winding for protection against continuous overload.

The Insulation Test circuit is supplied from transformer T2 designed to have large copper losses in the primary winding to limit the output current. At open circuit the transformer primary resistance referred to the secondary is 20 k $\Omega$  and appears as 2,7 M $\Omega$  due to the small conduction time of about 0,15 ms in a 20 ms period. For a 20 M $\Omega$  load

on the terminals, the conduction time increases such that the 20 k $\Omega$  resistance appears now as 280 k $\Omega$  which, together with R2, attenuates the output voltage to 500 V from the 600 V on open circuit. At short circuit the conduction time increases further and the 20 k $\Omega$  now appears as 120 k $\Omega$ , the current then is limited to 2 mA. The output is rectified and smoothed (0,22  $\mu$ F internal) leaving 5% ripple at the pass band limit, unless the load is largely capacitive. The smoothing capacitor will take 11 seconds (max.) to discharge after a test. On short circuit the meter will read beyond f.s.d. However, R1 provides a small deflection on the meter under open circuit conditions. This produces the "live infinity" to confirm that the instrument is functioning correctly on this test. The d.c. test voltage is switched to the 3-pin socket. The earth connection is at the low potential and the phase and neutral connections being joined together, are at the high -ve potential. The test voltage low potential is also switched to the Insulation/Flash probe socket via a relay (RL3). The test can therefore be applied via the socket earth and the phase and neutral connections or via the Insulation/Flash Probe socket and the phase and neutral 3-pin socket connections. The meter circuit is fed via a bridge rectifier in the phase and neutral circuit.

The Flash Test circuit is similar to the Insulation Test circuit and uses tapplings from the same transformer, T2. These tapplings are connected to the 3-pin socket and, via a reed relay (RL2), to the Insulation/Flash Probe socket in such a way that the phase and neutral connection is 1,5 kV with respect to the earth connection (for Class 1 flash tests) and the Insulation/Flash Probe socket is 3 kV with respect to the phase and neutral connections (for Class 2 flash tests). The test voltages stress the insulation and the leakage current flowing is displayed on the meter. On

---

open circuit the meter reads beyond f.s.d. and R16 provides a fixed leakage current to cause a "live zero", indicating that the instrument is functioning correctly on this test.

The Load Test circuit is supplied from transformer T1 (6 V a.c. nominal). The output of T1 is connected via R18 to the 3-pin socket phase and neutral connections. The meter circuit is connected to measure the voltage across R18. The phase to neutral impedance is thus measured and an indication given as to whether it is safe to apply the full voltage of the Operation Test.

The Operation Test simply switches the mains power supply via a relay RL1 to the 3-pin socket connections. A current transformer CT1 is incorporated in the connection to the neutral to supply the meter circuit via a bridge rectifier.

When the PAT2 itself is tested it may prove to be advantageous, for legal purposes and health and safety aspects, to keep a record of the results as proof of the validity of the instrument readings.



# Setting-Up Procedure

Notes of the basic setting-up procedure are given in the table below although it is recommended that a qualified instrument technician be employed to service the tester. To make any adjustments the instrument must be opened. NOTE: THIS WILL AUTOMATICALLY INVALIDATE ANY WARRANTY COVERING THE INSTRUMENT.

A stable sinusoidal supply voltage is recommended, equal to the nominal value of the mains supply on which the tester is used, for setting all but the 'Operation' range.

Step	Adjustment potentiometer	Adjustment for	Conditions for adjustment															
1	R12	Scale 1: 0,1 $\Omega$ mark	0,1 $\Omega$ resistor (able to carry 25 A) connected between Earth Bond lead crocodile clip and the 3-pin socket earth. Select Earth Bond Test, press TEST button and adjust.															
2	R3	Scale 2: 2 M $\Omega$ mark	2 M $\Omega$ resistor (able to withstand 600 V) connected between 3-pin socket neutral and earth. Select Insulation Test, press TEST button and adjust.															
3	R5	Scale 3: 5 mA mark	100 k $\Omega$ (approx.) variable resistor in series with a milliammeter connected between 3-pin socket neutral and earth. Select Flash Test, press TEST button and adjust variable resistor for the desired current on the milliammeter. Adjust potentiometer for same current reading on the meter.															
4	R19	Scale 4: green band limit	connect an 18 $\Omega$ 2 W resistor (9,1 $\Omega$ 4 W for the 110 V and 120 V models) between the 3-pin socket phase (line) and neutral. Select Load Test, press the 'TEST' button and adjust variable resistor until the pointer is at the right hand edge of the green band.															
5	R8	Scale 5: 3 kVA mark (220 V, 230 V and 240 V models) or 1,5 kVA mark (110 V and 120 V models)	3 kW electric fire connected to tester as a load. Tester supplied via a variac, for a 3 kW load on 240 V current drawn = 12,5 A. Connect clampmeter to measure load current (round one wire). Adjust variac until 12,5 A flows. Adjust potentiometer until meter indicates 3 kVA. Note:— See below for load/current setting for other supply voltages. <table style="margin-left: auto; margin-right: auto;"> <thead> <tr> <th>Supply voltage</th> <th>Load</th> <th>Current setting</th> </tr> </thead> <tbody> <tr> <td>110 V</td> <td>1,5 kW</td> <td>13,64 A</td> </tr> <tr> <td>120 V</td> <td>1,5 kW</td> <td>12,50 A</td> </tr> <tr> <td>220 V</td> <td>3 kW</td> <td>13,64 A</td> </tr> <tr> <td>230 V</td> <td>3 kW</td> <td>13,04 A</td> </tr> </tbody> </table>	Supply voltage	Load	Current setting	110 V	1,5 kW	13,64 A	120 V	1,5 kW	12,50 A	220 V	3 kW	13,64 A	230 V	3 kW	13,04 A
Supply voltage	Load	Current setting																
110 V	1,5 kW	13,64 A																
120 V	1,5 kW	12,50 A																
220 V	3 kW	13,64 A																
230 V	3 kW	13,04 A																

# Accessories

---

## SUPPLIED WITH THE INSTRUMENT

Earth Bond test lead with crocodile clip	Part no. 6231-043
H.V. test lead with retractable tip probe	Part no. 6420-061
Operating instruction book	Part no. 6171-047



## SUPPLIED AS AN OPTIONAL EXTRA

Earth Bond test lead with probe (probe has a replaceable tip)	Part no. 6331-229
'Safebloc' adaptor lead	Part no. 6331-230
H.V. test lead with retractable tip probe (alternative to that shown above, not illustrated)	Part no. 6430-229
Appliance safety log book (includes items below)	Part no. 6131-813
Log book ring binder	Part no. 6171-419
Test sheets (pack of 25 sheets)	Part no. 6171-417
Test stickers (pack of 3 sheets — 72 stickers)	Part no. 6171-418

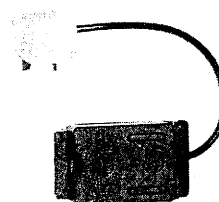

# Instrument Repairs and Spare Parts

---

The manufacturer's service and spare parts organisation for MEGGER® instruments:—

## **MEGGER INSTRUMENTS LIMITED,**

Archcliffe Road,  
Dover,  
Kent CT17 9EN,  
England.

Tel: Dover (0304) 202620  
Fax: Dover (0304) 207342  
Telex: 96283 Avomeg G

## **Approved Repair Companies**

A number of independent instrument repair companies in the U.K. have been approved for repair work on most MEGGER® instruments, using genuine MEGGER® spare parts. Their names and addresses are listed in the Warranty Card supplied with each new instrument.

## **Overseas**

Instrument owners outside Great Britain should consult the appointed Distributor/Agent for their country regarding spare parts and repair facilities. The Distributor/Agent will advise on the best course of action to take.

If returning an instrument to Britain for repair, it should be sent, freight pre-paid, to the address shown opposite. A copy of the Invoice and of the Packing Note should be sent simultaneously by airmail to expedite clearance through U.K. Customs.

A repair estimate showing return freight and other charges will be submitted to the sender, if required, before work on the instrument commences.

**NEW MEGGER® INSTRUMENTS ARE GUARANTEED FOR 12 MONTHS FROM THE DATE OF PURCHASE BY THE USER.**

# Components List

(Components are common to all models except where stated)

## High voltage p.c.b.

R1	Resistor	20 M $\Omega$ $\pm$ 5%	1/2 W
R2	Resistor	220 k $\Omega$ $\pm$ 5%	2 W
R14	Resistor (220 V–240 V models) (110 V–120 V models)	6,2 k $\Omega$ $\pm$ 5% 2,4 k $\Omega$ $\pm$ 5%	7 W 7 W
R15	Resistor	120 k $\Omega$ $\pm$ 5%	7 W
C1	Capacitor	0,22 $\mu$ F	630 V
C2	Capacitor	100 $\mu$ F	63 V electrolytic
D1	Diode	BYX 10	
D7	Diode	1N4148	
D8	Diode	1N4148	
D9	Zener diode	BZX87C51V	
D10	Diode	1N4148	
D11	Diode	1N4148	
RL2	Relay (reed)	part no. 25980-010	
RL3	Relay (reed)	part no. 25980-010	

## Meter p.c.b.

R3	Variable resistor	1 k $\Omega$ $\pm$ 20%	1/3 W
R4	Resistor	1,8 k $\Omega$ $\pm$ 2%	1/2 W
R5	Variable resistor	500 $\Omega$ $\pm$ 20%	1/3 W
R6	Resistor	200 $\Omega$ $\pm$ 2%	1/2 W
R7	Resistor	390 $\Omega$ $\pm$ 2%	1/2 W
R8	Variable resistor	5 k $\Omega$ $\pm$ 20%	1/3 W
R9	Resistor (220 V–240 V models) (110 V–120 V models)	330 $\Omega$ $\pm$ 2% 100 $\Omega$ $\pm$ 2%	1/2 W 1/2 W

R10	Resistor (220 V–240 V models) (110 V–120 V models)	180 $\Omega$ $\pm$ 2% 82 $\Omega$ $\pm$ 2%	1/2 W 1/2 W
R11	Resistor	3 k $\Omega$ $\pm$ 2%	1/2 W
R12	Variable resistor	500 $\Omega$ $\pm$ 20%	1/3 W
R13	Resistor	180 $\Omega$ $\pm$ 2%	1/2 W
R16	Resistor	6,8 M $\Omega$ $\pm$ 5%	1/2 W
R18	Resistor (220 V–240 V models) (110 V–120 V models)	18 $\Omega$ $\pm$ 5% 9,1 $\Omega$ $\pm$ 5%	4,3 W 4,3 W
R19	Variable resistor	5 k $\Omega$ $\pm$ 20%	1/3 W
R20	Resistor	18 k $\Omega$ $\pm$ 2%	1/2 W
C3	Capacitor	10 nF	25 V
C4	Capacitor	10 $\mu$ F	25 V electrolytic
D2	Diode	0A95	
D3	Diode	0A95	
D4	Zener diode	BZX79C3V9	
D5	Diode	0A95	
D6	Diode	0A95	

## Other Components

CB1	Circuit Breaker	part no. 25472-738
CT1	Current Transformer	part no. 6231-114
LP1	Lamp (neon)	part no. 25515-679
M1	Meter	part no. 6480-007
R1	Resistor	18 $\Omega$ $\pm$ 5% 4,3 W
RL1	Relay	part no. 25484-517
S1	Switch (function)	part no. 6280-182
S2	Switch (push-button)	part no. 25472-728
T1	Transformer (E.B.)	part no. 6331-311
T2	Transformer (H.V.)	part no. 6231-118
SG1	Surge Guard	part no. 6231-349

# Circuit Diagrams

for 220 V — 240 V models

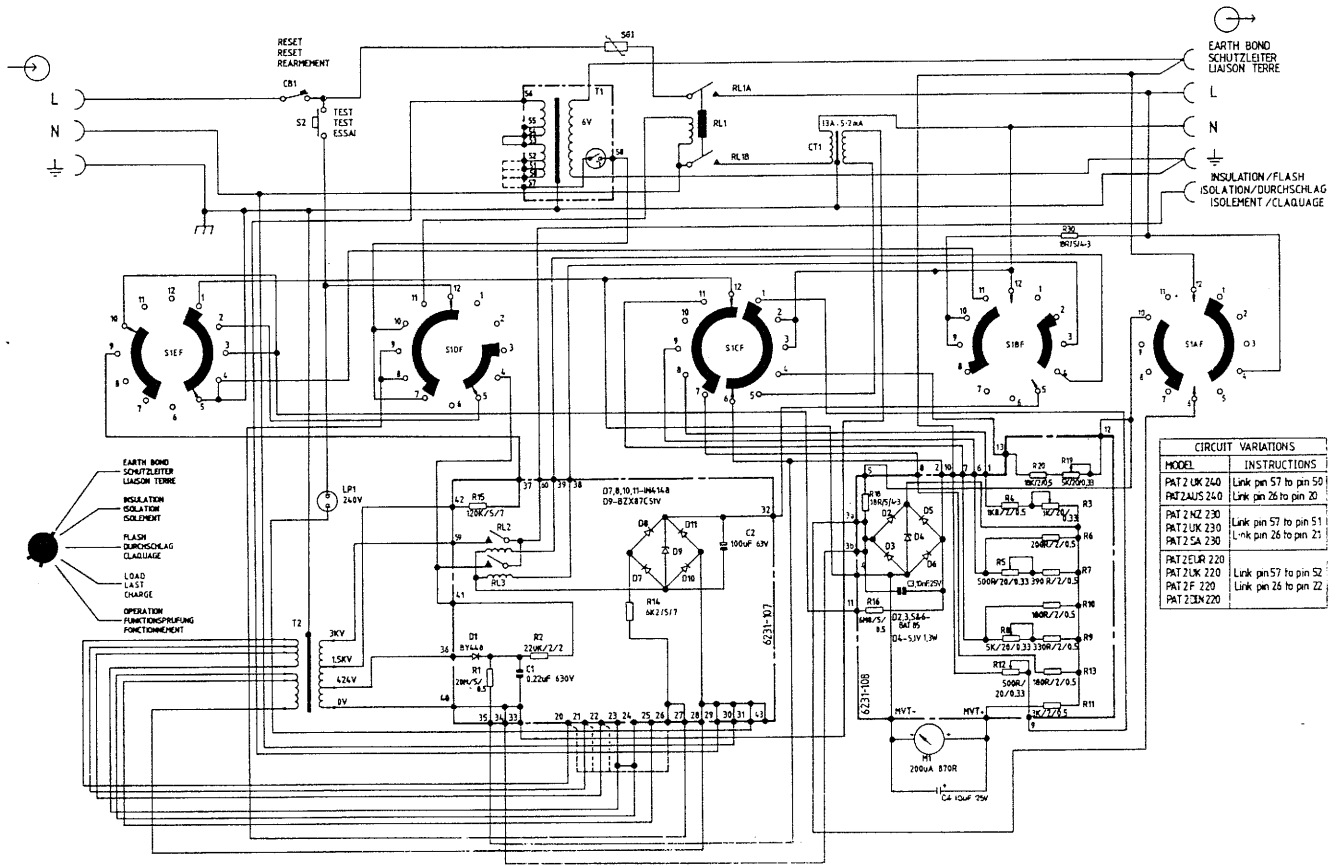

CIRCUIT VARIATIONS	
MODEL	INSTRUCTIONS
PAT 2 UK 240	Link pin 57 to pin 50
PAT 2 AUS 240	Link pin 26 to pin 20
PAT 2 NZ 230	Link pin 57 to pin 51
PAT 2 UK 230	Link pin 26 to pin 21
PAT 2 SA 230	Link pin 26 to pin 21
PAT 2 EUR 220	Link pin 57 to pin 52
PAT 2 UK 220	Link pin 26 to pin 22
PAT 2 J 220	
PAT 2 CIN 220	

for 110 V — 120 V models

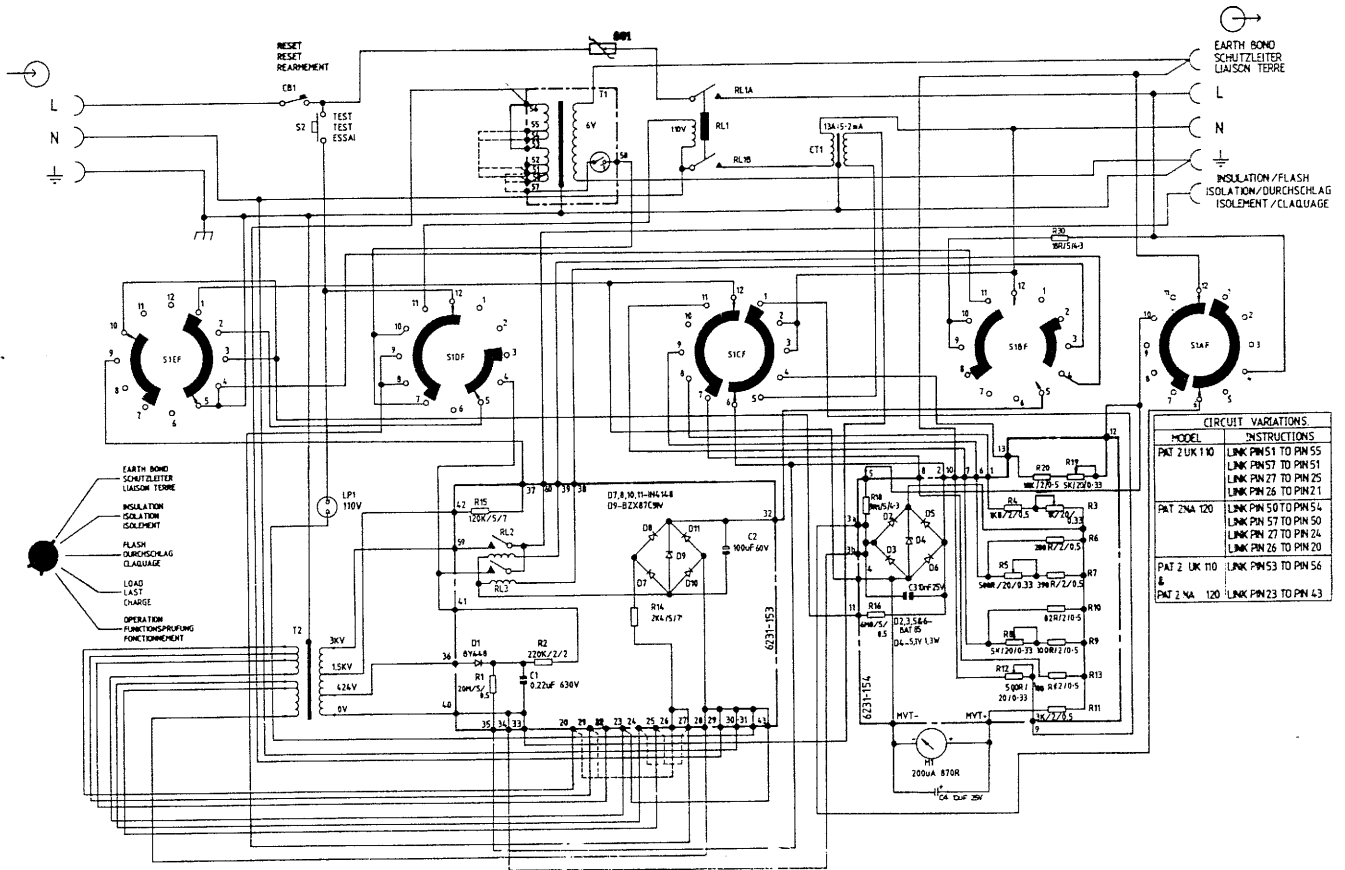



# **MEGGER INSTRUMENTS LIMITED**

Archcliffe Road, Dover, Kent CT17 9EN, England. Telephone: 0304 202620. Fax: 0304 207342. Telex: 96283 Avomeg G

*This instrument is manufactured in the United Kingdom.  
The company reserves the right to change the specification or design without prior notice.  
MEGGER is the registered Trade Mark of MEGGER INSTRUMENTS LIMITED.  
This data uses the comma as the decimal marker to align with general European usage.  
Parts of this instrument are the subject of patent applications.  
Copyright ©, MEGGER INSTRUMENTS LIMITED 1989  
Part No 6171-047 Edition 9 Printed in England SL/0,2k/9U*

*An AVO INTERNATIONAL company*

**MEGGER**